

JRC

Color Marine Radar JMA-5100 series



Worthy choice of Quality & Innovation

Combining the best features from the most popular JRC radars

《Special Features...We got'em!》

- **Designed for Flexibility**
 - Four unit configuration: Processor, Keyboard, Display and Antenna
 - Variable vertical or horizontal screen
 - Flush-mount or Console-mount installation available
 - Small size black box (processor)
- **To use jog-dial and trackball makes operation very easy**
- **Target trail time can be displayed and recorded simultaneously in two formats (equipped with background trail function)**
- **Scale has large off-center function (90% or more, 4x range display compared to normal)**
- **Direct connection to PC plotter**

"Radar System Data (RSD)," "Tracked Target Message (TTM*)," and "Own Ship Data (OSD)" output directly to the PC.
* TTM with optional MARPA installation.
- **GPS compass direct input, NSK unit connectivity < option >**
- **Full control of antenna from second station < option >**
- **New MARPA, Automatic Tracking Device - "ATD" - Semi ATA function < option >**
 - Greater performance by using the ARPA algorithm applied to large radars
 - Manual acquisition of 10 targets, target numbers automatically assigned
- **High-speed rotation (4 ft/6 kW) < option >**
- **Dedicated LCD display unit meets IPX5 waterproofing, vibration specifications IEC60945...adjustable brightness level for night sailing / fishing**



Japan Radio Co., Ltd.

JMA-5100 series 《Specifications》



Outline Drawing

Unit : mm

Model name	JMA-5104	JMA-5106	JMA-5110	
Summary				
Display format	Raster scanner PPI format			
Range scale	0.125/0.25/0.5/0.75/1.5/3/6/12/24/48nm	0.125/0.25/0.5/0.75/1.5/3/6/12/24/48/72nm		
Screen display information	Range scale, fixed range graduated interval, motion mode/direction mode, interference rejection, target expansion, course time, pulse width, ships course & direction, guard zone function display, STC/FTC mode (auto/manual), tuning display (including tuning mode), ships positioning display (Lat/Long), EBL1/EBL2 values (3-digit display), VRM1/VRM2 values (3-digit display), cursor value (direction, distance, Lat, Long), status displays.			
Antenna	NKE-2042	NKE-2062	NKE-2102	
	Diameter	2-feet radome	4-feet open	6-foot open
	Output	4kW	6kW	10kW
	Transmitting frequency	9410MHz±30MHz		
	Polarization characteristics	Horizontal beam width (-3 dB) 4°	Horizontal beam width (-3 dB) 2°	Horizontal beam width (-3 dB) 1.2°
	Rotation speed	Approx. 27rpm	Approx. 27rpm 48rpm (option)	Approx. 24rpm
	Pulse width	0.08μs/2250Hz, 0.25μs/1700Hz, 0.5μs/1200Hz, 1.0μs/650Hz		
	Transmitter/receiver switching	Circulator + diode		
	Frequency conversion	Microwave IC (MIC)		
	Tuning	Manual/automatic		
	Environment	<Temperature> -25°C to +55°C <Humidity> 93%, +40°C		
	Installation cable	CFQ-6912-20···20m standard		
	Indicator NCD-4310	Processor NDC-1260		
Screen display		Head-up/North-up/Course-up		
Motion mode		Relative motion/true motion		
Heading input		GPS/GPS compass/electronic compass		
Heading indicator		Electronic (equipped with temporary cancel key)		
EBL		2 (1 eccentric electronic cursor, with tracking), digital display (3 digits)		
VRM		2 (1 eccentric electronic cursor, with tracking), nm/km switchable, digital display (3 digits)		
Course display		Off, 15sec, 30sec, 1min, 3min, 6min, 15min, 30min, continuous		
Display unit NWZ-146				
LCD		10.4 inch color 640 x 480 pixel (VGA)		
Installation cable		5m (between the processor and the display unit)		
Operating unit NCE-7640				
Installation cable		5m (between the processor and the operating unit)		
Environmental conditions	<Temperature> -15°C to +55°C <Humidity> 93%, +40°C			
Input voltage(Voltage range)	DC 12V, 24V, 32V(DC 10.8V to 42.0V)		DC 24V, 32V(DC 21.6V to 42.0V)	
Options	Rectifier NBA-797 (AC 100/110/115/200/220/230V, single phase input)			
	MARPA unit NCA-868			
	NSK unit			
	Second station / Keyboard NCE-7640 / Display NWZ-146 30m cable CFQ-6912-30			

NKE-2042 2ft/4kW(Radome)

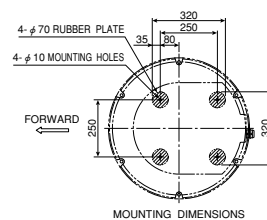
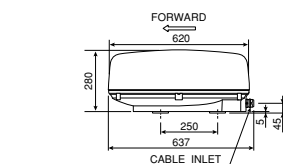

10.5kg

NKE-2062 4ft/6kW

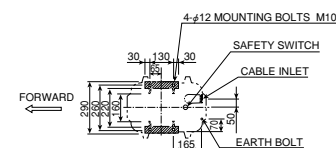
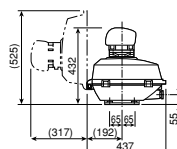
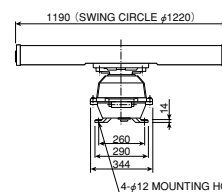

24.0kg

NWZ-146

Exterior dimensions diagram (screen in horizontal position)

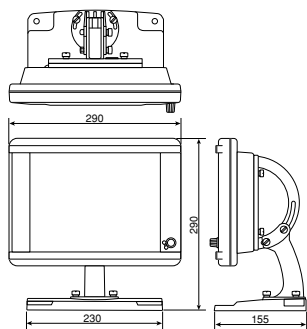

2.8kg

NCE-7640

Keyboard exterior diagram

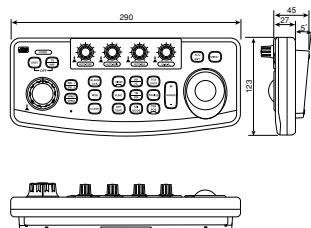

1.0kg

NDC-1260

Processor exterior diagram

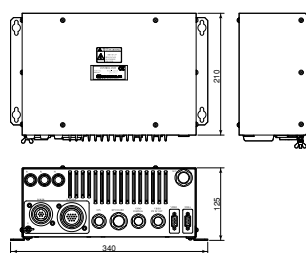

2.4kg

NKE-2102 6ft/10kW

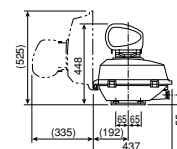
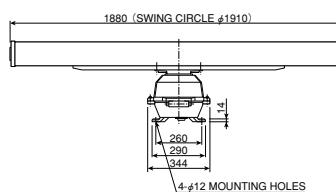

33.0kg

○ The display unit's LCD monitor swivels and tilts!

○ All operation buttons have variable illumination.

● Specifications may be subject to change without notice.

For further information, contact:



Since 1915

Japan Radio Co., Ltd.

URL <http://www.jrc.co.jp/eng/>

Main Office: Fujisawa bldg. 30-16, Ogikubo 4-chome
Suginami-ku, Tokyo 167-8540, Japan
Telephone: +81-3-6832-1816
Facsimile: +81-3-6832-1845

Overseas Branches : Seattle, Amsterdam, Athens, Manila
Liaison Offices : Taipei, Jakarta, Singapore, Hanoi,
Shanghai, Hamburg, New York