

Vertex Standard

VX-4500

VX-4600

OPERATING MANUAL

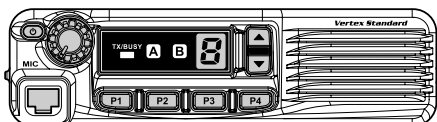

VX-4500

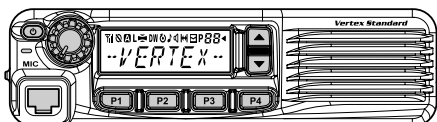

VX-4600

PROGRAMMABLE FUNCTIONS/FEATURES (※: VX-4600 ONLY)

Six Programmable Function Keys	2-tone Encode/Decode
5-tone Encode/Decode	MDC-1200® Encode/Decode
ARTS (Auto Range Transpond System)	REC & PLAY (Requires DVS-8)
Dimmer/Lamp	Clear Voice
Horn Alert	AF Min Volume
Public Address	Talk Around
Lock	Emergency
Beep OFF	Lone Worker
Encryption	Direct Channel Entry*
Scan	Code Up/Down*
Group Scan*	Code Set*
Dual Watch	Speed Dial*
FM-Scan (Follow-Me Scan)	DTMF Code Set*
TA Scan	ID Check*
VOX	TX Save Disable

Congratulations!

You now have at your fingertips a valuable communications tool: a Vertex Standard two-way radio! Rugged, reliable and easy to use, your Vertex Standard radio will keep you in constant touch with your colleagues for years to come, with negligible maintenance downtime.

Please take a few minutes to read this manual carefully. The information presented here will allow you to derive maximum performance from your radio.

We're glad you joined the Vertex Standard team. Call on us anytime, because communications is our business. Let us help you get your message across.

NOTICE !

There are no owner-serviceable parts inside the transceiver. All service jobs must be referred to an authorized Vertex Standard Service Representative. Consult your Authorized Vertex Standard dealer for installation of optional accessories.

SAFETY/WARNING INFORMATION

WARNING - DO NOT operate the **VX-4500/-4600** radio when any person(s) (bystanders) outside the vehicle are within the distances shown in the chart at the bottom of this section.

Safety Training information:

Antennas used for this transmitter must not exceed an antenna gain of 3 dBi. The radio must be used in vehicle-mount configurations with a maximum operating duty cycle not exceeding 50 %, in typical Push-to-Talk configurations.

This radio is restricted to occupational use, work related operations only where the radio operator must have the knowledge to control the exposure limits of passengers and bystanders by maintaining the minimum separation distance shown below.

Failure to observe these restrictions will result in exceeding the FCC RF exposure limits.

Antenna Installation:

For rear deck trunk installation, the antenna must be located at least the following distance away from rear-seat passengers in order to comply with the FCC RF exposure requirements.

For roof top installations, the antenna must be placed in the center of the roof.

Unsafe Radiation Distance

VHF Model	UHF Model
1.85 Feet (0.56 m)	2.36 Feet (0.72 m)

INTRODUCTION

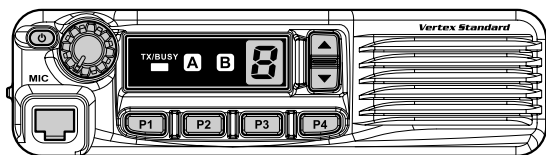

VX-4500

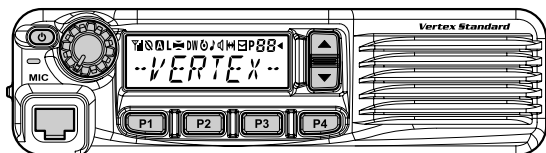

VX-4600

The **VX-4500/-4600** Series are full-featured FM transceivers designed for flexible mobile and base station business communications in the VHF or UHF Land Mobile bands. These transceivers are designed for reliable business communications in a wide variety of applications with a wide range of operating capability provided by their leading-edge design.

The **VX-4500** allows up to 8 memory channels. The **VX-4600** allows up to 512 memory channels which can each be programmed with an 8-character Alpha-Numeric Tag.

Important channel frequency data is stored in EEPROM and flash memory on the CPU, and is easily programmable by Vertex Standard dealers using a personal computer and the Vertex Standard Programming Cable and **CE115** Software.

The pages which follow will detail the many advanced features provided in the **VX-4500/-4600** Series transceiver. After reading this manual, you may wish to consult with your Network Administrator regarding precise details of the configuration of this equipment for use in your application.

For North American Users Regarding 406 MHz Guard Band

The U.S. Coast Guard and National Oceanographic and Atmospheric Administration have requested the cooperation of the U.S. Federal Communications Commission in preserving the integrity of the protected frequency range 406.0 to 406.1 MHz, which is reserved for use by distress beacons. Do not attempt to program this apparatus, under any circumstances, for operation in the frequency range 406.0 - 406.1 MHz if the apparatus is to be used in or near North America.

CONTROLS & CONNECTORS (VX-4500)

Front Panel

Important! - All buttons located on the Front Panel are Programmable Function (PF) keys, configured according to your network requirements and programmed by your Vertex Standard dealer. The instructions below describe a typically-configured radio.

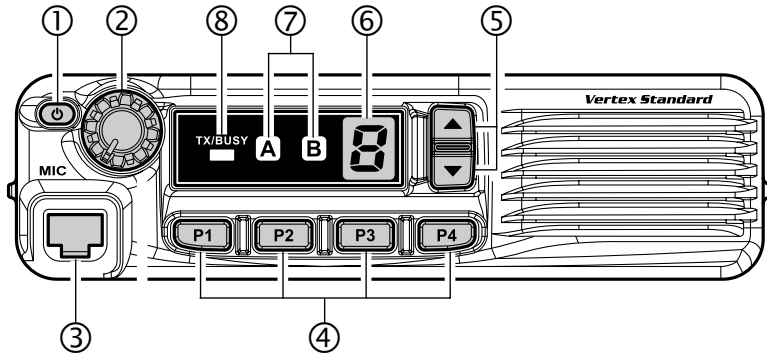

① PWR (⏻) Button

Press and hold in this button for 2 seconds to toggle the transceiver's power "on" and "off".

② VOL Knob

Turn this control clockwise to increase the volume.

③ Microphone Jack

Connect the microphone plug to this jack.

④ [P1] - [P4] Keys (Programmable Function Keys)

These keys can be set up for special applications, such as High/Low power selection, Monitor, Talk-Around, etc., as determined by your network requirements and programmed by your Vertex Standard dealer.

⑤ [▼]/[▲] Keys (Programmable Function Keys)

In the factory default, pressing either key changes the current channel.

⑥ Channel Number Indicator

Indicates the operating channel.

CONTROLS & CONNECTORS (VX-4500)

⑦ Transceiver Status Indicator

The “A” and “B” indicators show current transceiver status, which can be customized via programming by your Vertex Standard dealer to meet your communications/network requirements. The possible “A” and “B” displays are explained below.

⑧ TX/BUSY Indicator

Indicates transceiver’s Transmit/Receive Status.

TRANSCEIVER STATUS INDICATOR

STATUS	INDICATOR		DESCRIPTION
	A	B	
MONI			This indicator is illuminated constantly when the signaling feature is disabled. The indicator blinks while the audio is passing normally.
SCAN CH			Illuminates the indicator when the scan enabled channel is recalled.
PRI-1			Illuminates the indicator when the Priority-1 channel is activated.
Low Power			Illuminates the indicator when the radio’s transmitter is set to the “Low Power” mode.
TA (Talk Around)			Illuminates the indicator when the “Talk Around” function is activated.
Encryption			Illuminates the indicator when the “Voice Scrambler” function is enabled.
Emergency			Illuminates the indicator when the “Emergency” feature is activated.
Horn Alert			Illuminates the indicator when the “Horn Alert” feature is activated.
PA (Public Address)			Illuminates the indicator when the radio is turned to a PA amplifier.
Lock			Illuminates the indicator when the “Lock” feature is activated.
ACC2			Illuminates the indicator when the output port “2” on the Accessory Connector is turned to “ON”.
RFC			Illuminates the indicator when the radio is in the “Ready for Communication” condition while operating with the 2-Tone or 5-Tone signaling.
REC/PLAY (Required optional Unit)			Illuminates the indicator when the incoming message is recorded or storage message is played back.

CONTROLS & CONNECTORS (VX-4600)

Front Panel

Important! - All buttons located on the Front Panel are Programmable Function (PF) keys, configured according to your network requirements and programmed by your Vertex Standard dealer. The instructions below describe a typically-configured radio.

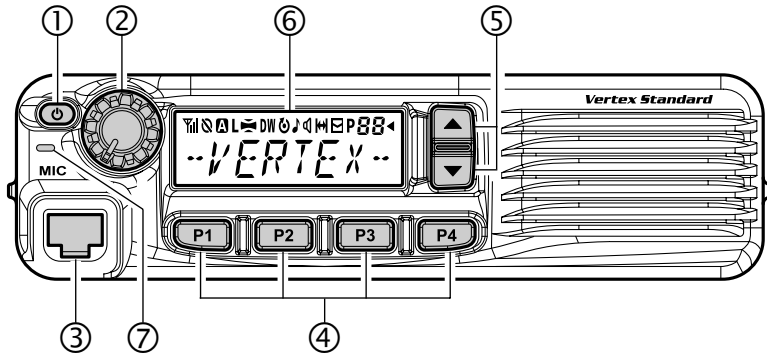

① PWR (⏻) Button

Press and hold in this button for 2 seconds to toggle the transceiver's power "on" and "off".

② VOL Knob

Turn this control clockwise to increase the volume.

③ Microphone Jack

Connect the microphone plug to this jack.

④ [P1] - [P4] Keys (Programmable Function Keys)

These keys can be set up for special applications, such as High/Low power selection, Monitor, Talk-Around, etc., as determined by your network requirements and programmed by your Vertex Standard dealer.

⑤ [▼]/[▲] Keys (Programmable Function Keys)

In the factory default, pressing either key changes the current channel (and displayed channel number or name). Holding in either key for more than 1.5 second causes the radio to begin stepping (repeatedly) upward or downward through the channels.

CONTROLS & CONNECTORS (VX-4600)

⑥ LCD (Liquid Crystal Display)

The display includes a 8-character alpha-numeric section showing Channel name tags/identity information and error messages, and an upper icon row displaying feature status (see below).

⑦ TX/BUSY Indicator

Indicates transceiver's Transmit/Receive Status.

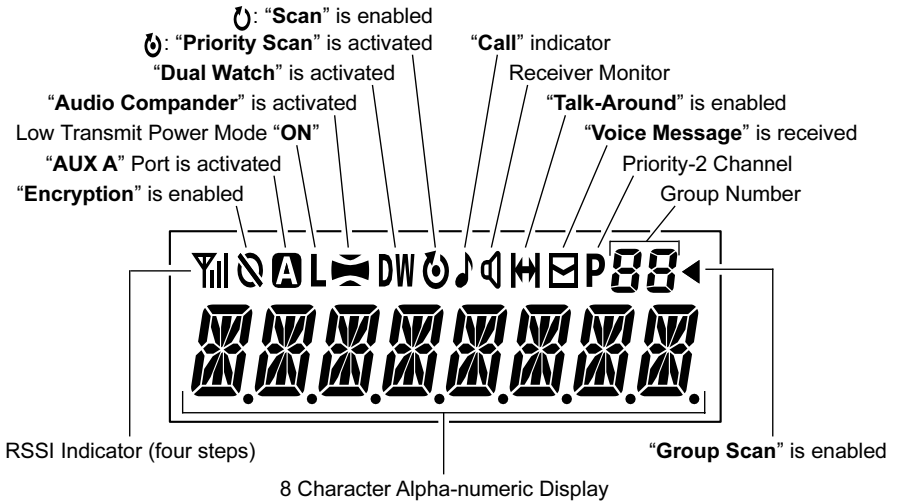

CONTROLS & CONNECTORS

Rear Panel

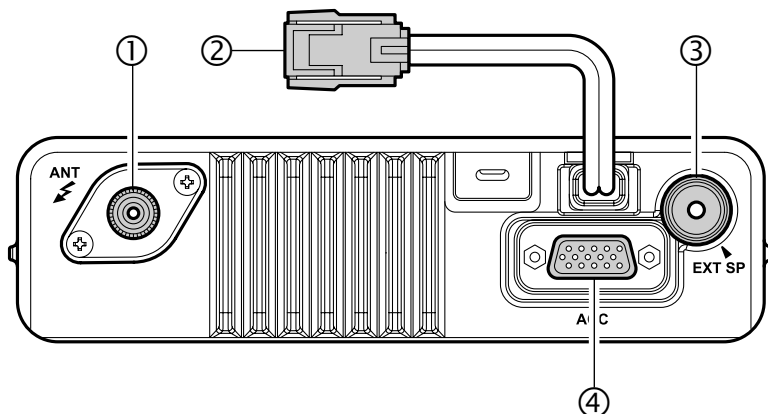

① Antenna Jack

The 50-Ohm coaxial feedline to the antenna must be connected here, using a mini-UHF plug.

② 13.6V DC Cable Pigtail with Connector

The supplied DC power cable must be connected to this 2-pin connector. Use only the supplied fused cable, extended if necessary, for power connection.

⚠ Replace only with the same or equivalent type fuse.

③ External Speaker Jack

An external loudspeaker may be connected to this 2-contact, 3.5-mm mini-phone jack.

Caution: Do not connect either wire of this line to ground, and be certain that the speaker has adequate capability to handle the audio output (12 W) from the radio.



④ D-Sub 15-Pin Accessory Connector

External TX audio line input, PTT (Push To Talk), Squelch, and external RX audio line output signals may be obtained from this connector for use with accessories such as data transmission/reception modems, and external Channel control input etc.

BASIC OPERATION OF THE TRANSCEIVER

Important! - Before turning on the radio the first time, confirm that the power connections have been made correctly and that a proper antenna is connected to the antenna jack.

Switching Power ON/OFF

- Press and hold in the **PWR**() button for 2 seconds to turn the radio on. The display will become illuminated.
- Press the []/[] key to choose the desired operating channel. In the **VX-4600**, a channel name will appear on the display.
- In the **VX-4600**, if you want to select an operating channel from a different group, press the **PF** (Programmable Function) key which is programmed to the Group Up/Down feature to select the group you want before selecting the operating channel. See page 8 for more information on the Programmable Function keys.

Setting the Volume

- Turn the **VOL** knob clockwise to increase the volume, and counterclockwise to decrease it.

Transmitting

- To transmit, monitor the channel and make sure it is clear.
THIS IS AN FCC REQUIREMENT!
- Press the **PF** key which is programmed to the Monitor feature to listen for channel activity.
- When receiving a call, transmit only after the incoming call ends. The radio cannot receive a call and transmit simultaneously.
- Press the **PTT** switch.
- If the channel is clear, the **TX/BUSY** indicator will glow red. The radio is now transmitting. While holding in the **PTT** switch, speak across the face of the microphone in a clear and normal voice. For best transmission, hold the microphone about 1-1/2 to 2 inches (4 ~ 5 cm) away from your mouth. Release the **PTT** switch to receive.
- If the Busy Channel Lockout feature has been programmed on a channel, the radio will not transmit when a carrier is present. Instead, the radio will generate a short beep three times and the **VX-4600** indicates "CH BUSY" on the display. Release the **PTT** switch and wait for the channel to be clear of activity.
- If CTCSS or Digital Coded Squelch (DCS) Lockout has been programmed on a channel, the radio can transmit only when there is no carrier being received or when the carrier being received includes the correct CTCSS tone or DCS code.

BASIC OPERATION OF THE TRANSCEIVER

Transmit Time-Out Timer

If the selected channel has been programmed for automatic time-out, you must limit the length of each transmission. While transmitting, a beep will sound 10 seconds before time-out. Another beep will sound just before the deadline; the red “**TX**” indicator will disappear and transmission will cease soon thereafter. On the **VX-4600**, “TIME OUT” will be indicated on the display. To resume transmitting, you must release the **PTT** switch and wait for the “penalty timer” to expire (if you press the **PTT** switch before this timer expires, the timer restarts, and you will have to wait another “penalty” period)

Key Lock

In order to prevent accidental operating function/feature change or inadvertent transmission, various aspects of the front panel’s keys may be locked out.

To activate the Locking feature, press and hold in the [**P1**] key while turning the radio on. To disable the Locking feature, repeat this power-on procedure.

ADVANCED OPERATION

Programmable Function (PF) Keys

The **VX-4500/-4600** includes six Programmable Function (**PF**) keys. The **PF** button functions can be customized, via programming by your Vertex Standard dealer, to meet your communications/network requirements. Some features may require the purchase and installation of optional internal accessories. The possible **PF** key programming features are illustrated below, and these functions are explained on the pages to follow. For further details, contact your Vertex Standard dealer. For future reference, check the box next to the function that has been assigned to each **PF** key on your particular radio, and keep it handy.

ADVANCED OPERATION

Function	PROGRAMMABLE KEY (PRESS KEY/PRESS AND HOLD KEY)						MH-75A8J MICROPHONE KEY (PRESS KEY/PRESS AND HOLD KEY)					
	P1	P2	P3	P4	▲	▼	A	B	C	D	*	#
None	/	/	/	/	/	/	/	/	/	/	/	/
Monitor	/	/	/	/	/	/	/	/	/	/	/	/
Monitor -Momentarily-	/-	/-	/-	/-	/-	/-	/-	/-	/-	/-	/-	/-
Dimmer/Lamp	/	/	/	/	/	/	/	/	/	/	/	/
Low Power	/	/	/	/	/	/	/	/	/	/	/	/
Encryption	/	/	/	/	/	/	/	/	/	/	/	/
SET*	/	/	/	/	/	/	/	/	/	/	/	/
SQL OFF	/	/	/	/	/	/	/	/	/	/	/	/
SQL OFF -Momentarily-	/-	/-	/-	/-	/-	/-	/-	/-	/-	/-	/-	/-
SQL Set*	/	/	/	/	/	/	/	/	/	/	/	/
Beep OFF	/	/	/	/	/	/	/	/	/	/	/	/
VOX	/	/	/	/	/	/	/	/	/	/	/	/
VOX Set*	/	/	/	/	/	/	/	/	/	/	/	/
Clear Voice	/	/	/	/	/	/	/	/	/	/	/	/
AF Min Volume	/	/	/	/	/	/	/	/	/	/	/	/
Horn Alert	/	/	/	/	/	/	/	/	/	/	/	/
PA (Public Address)	/	/	/	/	/	/	/	/	/	/	/	/
EXT ACC 1	/-	/-	/-	/-	/-	/-	/-	/-	/-	/-	/-	/-
EXT ACC 2	/	/	/	/	/	/	/	/	/	/	/	/
Emergency	/-	/-	/-	/-	/-	/-	/-	/-	/-	/-	/-	/-
Lone Worker	/	/	/	/	/	/	/	/	/	/	/	/
Group Up*	/	/	/	/	/	/	/	/	/	/	/	/
Group Down*	/	/	/	/	/	/	/	/	/	/	/	/
Channel Up	/	/	/	/	/	/	/	/	/	/	/	/
Channel Down	/	/	/	/	/	/	/	/	/	/	/	/
Speed CH Up*	/-	/-	/-	/-	/-	/-	/-	/-	/-	/-	/-	/-
Speed CH Down*	/-	/-	/-	/-	/-	/-	/-	/-	/-	/-	/-	/-
PRI-1	/	/	/	/	/	/	/	/	/	/	/	/
PRI-2	/	/	/	/	/	/	/	/	/	/	/	/
PRI-2 Set	/	/	/	/	/	/	/	/	/	/	/	/
PRI-2 Disable	/	/	/	/	/	/	/	/	/	/	/	/
Direct CH 1	/	/	/	/	/	/	/	/	/	/	/	/
Direct CH 2	/	/	/	/	/	/	/	/	/	/	/	/
Direct CH 3	/	/	/	/	/	/	/	/	/	/	/	/
Direct CH 4	/	/	/	/	/	/	/	/	/	/	/	/
Direct CH Entry*	/-	/-	/-	/-	/-	/-	/	/	/	/	/	/
Scan	/	/	/	/	/	/	/	/	/	/	/	/
Group Scan*	/	/	/	/	/	/	/	/	/	/	/	/
Dual Watch	/	/	/	/	/	/	/	/	/	/	/	/
FM-Scan	/	/	/	/	/	/	/	/	/	/	/	/
Scan Set	/	/	/	/	/	/	/	/	/	/	/	/
Group Scan Set*	/	/	/	/	/	/	/	/	/	/	/	/
TA Scan	/	/	/	/	/	/	/	/	/	/	/	/
Talk Around	/	/	/	/	/	/	/	/	/	/	/	/
Reset	/	/	/	/	/	/	/	/	/	/	/	/

※: This function cannot assign to **VX-4500**.

ADVANCED OPERATION

Function	PROGRAMMABLE KEY (PRESS KEY/PRESS AND HOLD KEY)						MH-75A&J MICROPHONE KEY (PRESS KEY/PRESS AND HOLD KEY)					
	P1	P2	P3	P4	▲	▼	A	B	C	D	*	#
CALL 1	/	/	/	/	/	/	/	/	/	/	/	/
CALL 2	/	/	/	/	/	/	/	/	/	/	/	/
CALL 3	/	/	/	/	/	/	/	/	/	/	/	/
CALL 4	/	/	/	/	/	/	/	/	/	/	/	/
CALL 5	/	/	/	/	/	/	/	/	/	/	/	/
Code Up*	/	/	/	/	/	/	/	/	/	/	/	/
Code Down*	/	/	/	/	/	/	/	/	/	/	/	/
Code Set*	/	/	/	/	/	/	/	/	/	/	/	/
Speed Dial*	/	/	/	/	/	/	/	/	/	/	/	/
DTMF Code Set*	-/-	-/-	-/-	-/-	-/-	-/-	/	/	/	/	/	/
Call	/	/	/	/	/	/	/	/	/	/	/	/
Status Set*	/	/	/	/	/	/	/	/	/	/	/	/
Status Up*	/	/	/	/	/	/	/	/	/	/	/	/
Status Down*	/	/	/	/	/	/	/	/	/	/	/	/
Status Check*	/	/	/	/	/	/	/	/	/	/	/	/
Duty	/	/	/	/	/	/	/	/	/	/	/	/
ID Check*	/	/	/	/	/	/	/	/	/	/	/	/
Option Switch 1	/-	/-	/-	/-	/-	/-	/-	/-	/-	/-	/-	/-
Option Switch 2	/	/	/	/	/	/	/	/	/	/	/	/
REC	/	/	/	/	/	/	/	/	/	/	/	/
PLAY	/	/	/	/	/	/	/	/	/	/	/	/
TX Save Disable	/	/	/	/	/	/	/	/	/	/	/	/
Lock	/	/	/	/	/	/	/	/	/	/	/	/

※: This function cannot assign to **VX-4500**.

ADVANCED OPERATION

Description of Operating Functions

MONITOR

Press (or press and hold) the assigned programmable key to cancel any signaling features.

MONITOR -MOMENTARILY-

Cancel any signaling features while pressing the assigned programmable key.

DIMMER/LAMP

In the **VX-4600**, press (or press and hold) the assigned programmable key to select the brightness level of the display and keypad (“Dimmer” function). Available selections are four levels.

In the **VX-4500**, press (or press and hold) the assigned programmable key to toggle the back light of the display and keypad “On” and “Off” (“Lamp” function).

LOW POWER

Press (or press and hold) the assigned programmable key to set the radio’s transmitter to the “Low Power” mode. Press (or press and hold) the key again to return to “High Power” operation when in difficult terrain.

In the **VX-4600**, when the radio’s transmitter is set to “Low Power” mode, the “**L**” icon will be indicated on the display.

ENCRYPTION

When the Voice Scrambler feature is enabled, press (or press and hold) the assigned programmable key to toggle the voice encryption “On” and “Off”.

In the **VX-4600**, when the Voice Scrambler feature is activated, the “**Q**” icon will be indicated on the display.

SET (This function is only available in the VX-4600)

Press (or press and hold) the assigned programmable key to activate the “User Set” (Menu) Mode.

SQL OFF

Press (or press and hold) the assigned programmable key to open the SQL to hear background noise (unmute the audio).

ADVANCED OPERATION

SQL OFF -MOMENTARILY-

Opens the SQL to hear background noise (unmute the audio) while pressing the assigned programmable key.

SQL SET

You can manually adjust the squelch level using this function:

- Press (or press and hold) the assigned programmable key. A tone will sound, and the current squelch level will appear on the display.
- Press the [▼]/[▲] key to select the desired squelch level.
- Press the [P4] key (or **MH-75A8J**'s [D] key) to store the new setting. The display indicates “- SET -” briefly, then reverts to the normal channel indication. You may cancel the new setting by pressing the [P3] key (or **MH-75A8J**'s [C] key). In this case, the display indicates “- CANCEL -” briefly.

BEEP OFF

Press (or press and hold) the assigned programmable key to toggle the beeper “On” and “Off”.

VOX

Press (or press and hold) the assigned programmable key to turn the VOX function “On” or “Off”. You may disable the VOX function temporarily by pressing the **PTT** switch.

VOX SET (This function is only available in the VX-4600)

You can manually adjust the VOX Gain using this function:

- Press (or press and hold) the assigned programmable key. A tone will sound, and the current VOX Gain level will appear on the display.
- Press the [▼]/[▲] button to select the desired VOX Gain level.
- Press the [P4] key (or **MH-75A8J**'s [D] key) to store the new setting. The display indicates “- SET -” briefly, then reverts to the normal channel indication. You may cancel the new setting by pressing the [P3] key (or **MH-75A8J**'s [C] key). In this case, the display indicates “- CANCEL -” briefly.

CLEAR VOICE

Press (or press and hold) the assigned programmable key to activate the Clear Voice feature. When you are operating in a noisy environment, activate the Clear Voice feature. Again press (or press and hold) the assigned programmable key to disable the Clear Voice feature.

ADVANCED OPERATION

AF MIN VOLUME

Press (or press and hold) the assigned programmable key to reduce the audio output to the (lower) level programmed by your Vertex Standard dealer.

HORN ALERT

Press (or press and hold) the assigned programmable key to turn the Horn Alert function “On” or “Off”. If you receive a call from the base station with the signaling, horn alert will be activated and your vehicles horn will sound.

PA (PUBLIC ADDRESS)

Press (or press and hold) the assigned programmable key to use the transceiver as a PA amplifier. The public address can be used even while scanning and receiving a call.

EXT ACC 1

Activates the output port “1” of the D-Sub 15-pin Accessory Connector while pressing the assigned programmable key.

EXT ACC 2

Press (or press and hold) the assigned programmable key to toggle the output port “2” of the D-Sub 15-pin Accessory Connector “On” and “Off”.

EMERGENCY

The **VX-4500/-4600** series includes an “Emergency” feature which may be useful if you have someone monitoring on the same frequency as your transceiver’s channel.

Press the assigned programmable key to initiate an emergency call. For further details contact your Vertex Standard dealer.

LONE WORKER

Press (or press and hold) the assigned programmable key to toggle the Lone Worker feature “On” and “Off”.

The Lone Worker feature is designed to emit an alarm for 30 seconds when the Lone Worker Timer (programmed by your Vertex Standard dealer) has expired. If the user does not reset the timer by pressing the **PTT** switch, the radio switches to the Emergency mode.

To revive the radio from the Emergency mode, just press (or press and hold) the programmable key which is assigned the Emergency feature or turn off the radio.

ADVANCED OPERATION

GROUP UP/DOWN (This function is only available in the VX-4600)

Press (or press and hold) the assigned programmable key to select a different group of channels.

CHANNEL UP/DOWN

Press (or press and hold) the assigned programmable key (generally the [▲]/[▼] key) to select a different channel within the current group.

SPEED CH UP/DOWN (This function is only available in the VX-4600)

Press and hold the assigned programmable key causes the radio to begin stepping (repeatedly) upward or downward through the channels.

PRI-1/PRI-2

Press (or press and hold) the assigned programmable key to recall the pre-programmed priority channel directly. This is pre-programmed by your Vertex Standard dealer.

PRI-2 SET

Press (or press and hold) the assigned programmable key to toggle the current channel to the priority channel 2 “enable” and “disable”.

PRI-2 DISABLE

Press (or press and hold) the assigned programmable key to disable the priority channel 2 of the group temporarily.

DIRECT CH 1 TO DIRECT CH 4

Press (or press and hold) the assigned programmable key to recall the pre-programmed channel directly. This is pre-programmed by your Vertex Standard dealer.

ADVANCED OPERATION

DIRECT CH ENTRY

(This function is only available in the **VX-4600** and requires the **Optional MH-75A8J 16-Keypad Microphone**)

You can recall the desired channel directly using this function:

- Press (or press and hold) the assigned programmable key. A tone will sound, and the current group/channel number will appear on the display.
- Enter the desired group number (two digits) and channel number (two digits) on the **MH-75A8J**'s keypad.
- Press the [**P4**] key (or **MH-75A8J**'s [**D**] key) to store the new setting. The display indicates “- SET -” briefly, then reverts to the normal channel indication. You may cancel the new setting by pressing the [**P3**] key (or **MH-75A8J**'s [**C**] key). In this case, the display indicates “- CANCEL -” briefly.

SCAN

The Scanning feature is used to monitor multiple channels programmed into the transceiver. While scanning, the transceiver will check each channel for the presence of a signal, and will stop on a channel if a signal is present.

To activate scanning:

- Press (or press and hold) the assigned programmable key to activate scanning on the channel which is pre-programmed into the scan list by your Vertex Standard dealer.
- The scanner will search the programmed channels, looking for active ones; it will pause each time it finds a channel on which someone is speaking.
- Press (or press and hold) the assigned programmable key again to disable scanning. Operation will revert to the programmed revert channel.

Note: Your Vertex Standard dealer may have programmed your radio to stay on one of the following channels if you press the **PTT** switch during the scanning pause:

- “Scan Pause” channel (“Talk Back”)
- “Last Busy” channel
- “Priority-1/-2” channel
- “User Programmed” channel (“Select Channel”)
- “Scan Start” channel

ADVANCED OPERATION

GROUP SCAN (This function is only available in the VX-4600)

The Scanning feature is used to monitor multiple channels programmed into the transceiver. While scanning, the transceiver will check each channel of the programmed group for the presence of the signal, and will stop on a channel if a signal is present.

Press (or press and hold) the assigned programmable key to activate the scanning on the selected groups.

DUAL WATCH

The Dual Watch feature is similar to the SCAN feature, except that only two channels are monitored:

- The current operating channel; and
- The Priority-1/-2 channel.

To activate Dual Watch:

- Press (or press and hold) the assigned programmable key.
- The scanner will search the two channels; it will pause each time it finds a channel on which someone is speaking.

To stop Dual Watch:

- Press (or press and hold) the assigned programmable key.
- Operation will revert to the “Dual Watch Start” channel.

FM-SCAN (FOLLOW-ME SCAN)

FM-Scan (Follow-Me Scan) feature checks a User-assigned Priority Channel regularly as you scan the other channels. Thus, if only Channels 1, 3, and 5 (of the 8 available channels) are designated for “Scanning,” the user may nonetheless assign Channel 2 as the “User-assigned” Priority Channel via the FM-Scan (Follow-Me Scan).

To activate the FM-Scan (Follow-Me Scan), first select the channel you want to designate as the “User-Assigned Priority Channel” and press (or press and hold) the assigned programmable key. Then press (or press and hold) the Channel Up/Down key (generally the [▲]/[▼] key) to recall to the “Scanning Start” channel which has been programmed by your dealer to activate the scanner. When the scanner stops on an “Active” channel, the User-assigned Priority Channel will automatically be checked every few seconds; if activity is found on the User-assigned Priority Channel, the radio will switch between it and the Dealer-Assigned Priority Channel, if any.

ADVANCED OPERATION

SCAN SET

Press (or press and hold) the assigned programmable key to add/delete the current channel to/from your scanning list.

In the **VX-4500**, when you delete channel, the “**A**” or “**B**” indicator will turn off, if the “SCAN CH” status is assigned to the “**A**” or “**B**” indicator. To restore a particular channel to your scanning list, press (or press and hold) the assigned programmable key again; the “**A**” or “**B**” indicator will illuminate, if the “SCAN CH” status is assigned to the “**A**” or “**B**” indicator.

In the **VX-4600**, when you delete channel, the display indicates “- SCN SKIP -” briefly and the “**U**” icon will disappear from the display. To restore a particular channel to your scanning list, press (or press and hold) the assigned programmable key again; the display indicates “- SCN SET -” briefly and “**U**” icon will appear on the display.

Furthermore, press (or press and hold) the assigned programmable key while the scanner is paused, this removes the channel from the scan list temporarily.

GROUP SCAN SET (This function is only available in the VX-4600)

You may wish to have the Scanner pass through more than one Group during the scanning process (normally, scanning is performed within the current group only). **To include the current Group in the scanning loop**, press (or press and hold) the assigned programmable key (the “**◀**” icon will appear on the display). **To remove a current Group from Group Scan**, press (or press and hold) the assigned programmable key again (the “**◀**” icon will disappear from the display).

TA SCAN

Press (or press and hold) the assigned programmable key to toggle the TA (Talk Around) scan feature “On” and “Off.”

While TA scan is enabled, the transceiver will search both the transmit and receive frequencies (In the **VX-4600**, the “**↔**” icon will blink on the display). When a signal is encountered on the receive frequency, the transceiver will pause until the signal disappears (In the **VX-4600**, “**↔**” icon will appear but not blink). When a signal is encountered on the transmit frequency, the transceiver will check for activity on the receive frequency every few seconds (interval programmed by your Ver-tex Standard dealer).

Note: The TA Scan feature does not activate on the Simplex Channel.

ADVANCED OPERATION

TALK AROUND

Press (or press and hold) the assigned programmable key to activate the Talk Around feature when you are operating on duplex channel systems (separate receive and transmit frequencies, utilizing a “repeater” station). The Talk Around feature allows you to bypass the repeater station and talk directly to a station that is nearby. This feature has no effect when you are operating on “simplex” channels, where the receive and transmit frequencies are already the same.

In the **VX-4600**, when the “TA” function is activated, the “” icon will be indicated on the display.

Note that your Vertex Standard may have made provision for “Talk Around” channels by programming “repeater” and “Talk Around” frequencies on two adjacent channels. If so, the key may be used for one of the other Pre-Programmed Functions.

Note: The Talk Around feature does not activate on the Simplex Channel.

RESET

Press (or press and hold) the assigned programmable key to reset the RFC (Ready for Communication) condition.

CALL 1 TO CALL 5

Press (or press and hold) the assigned programmable key to send a 2-Tone or 5-Tone sequential burst which is pre-programmed.

CODE UP/DOWN (This function is only available in the VX-4600)

Press (or press and hold) the assigned programmable key to select a 2-Tone or 5-Tone encode code from the pre-programmed encode list.

CODE SET (This function is only available in the VX-4600)

Press (or press and hold) the assigned programmable key to change the 5-Tone encoding digit. To change the tones, select the desired digit using the [P1]/[P2] keys, then change the number using the [▼]/[▲] keys.

You may enter the 5-Tone encoding code directly from the microphone’s numeric key ([0] - [9]) and [*] key (wild card), if the optional **MH-75A8J** microphone is used.

ADVANCED OPERATION

SPEED DIAL (This function is only available in the VX-4600)

Your Vertex Standard dealer may have pre-programmed Auto-Dial telephone number memories into your radio.

To dial a number:

- ❑ If the optional **MH-75A8J** microphone is used, press (or press and hold) the assigned programmable key, then press the microphone's numeric key ([0] - [9]) corresponding to the Auto-Dial memory number which is provided by your Vertex Standard Dealer, then press the **PTT** switch. The DTMF tones sent during the dialing sequence will be heard in the speaker.
- ❑ If the normal (without keypad) microphone is used, press the [▼]/[▲] keys to select the Auto-Dial memory number which is pre-programmed by your Vertex Standard dealer, then press the **PTT** switch. The DTMF tones sent during the dialing sequence will be heard in the speaker.

DTMF CODE SET

(This function is only available in the **VX-4600** and requires the Optional **MH-75A8J** 16-Keypad Microphone)

Press (or press and hold) the assigned programmable key to start storing the DTMF dialing sequence. After entering to enter all DTMF digits from the **MH-75A8J**'s keypad, you can transmit the code by pressing the **PTT** switch.

ADVANCED OPERATION

CALL

When using the DTMF Paging System

This feature, if enabled, allows the user to change the 3-digit Page Call code, used to call other similarly-equipped stations. Press (or press and hold) the assigned programmable key, followed by the three digits representing the Page Call code of the station you wish to call. Three tones will be heard after the last key is pressed (the new code will now be transmitted).

The receiver squelch of the other station will be opened, and you can begin communication.

When using the 2-tone/5-tone Signaling System

This feature, if enabled, press (or press and hold) the assigned programmable key to send a 2-tone/5-tone sequential tone.

When using the MDC1200 System

This feature, if enabled, press (or press and hold) the assigned programmable key to send an MDC1200 code.

- Press (or press and hold) the assigned programmable key to enter the “Call Menu” mode.
- Press the [▼]/[▲] keys (or [P1]/[P2] keys) to select the desired Call mode, then press the [P4] key to accept the selection. (You may cancel the selection by pressing the [P3] key).
- Press the [▼]/[▲] (or [P1]/[P2] keys) to select the station to be called. You may enter the station’s ID number (four digits) directly from the microphone’s key ([0] - [9], [A] - [D], [#]: substitute for “E”, and [*]: wild card), if the optional **MH-75A8J** microphone is used.
- Press the **PTT** switch to send an MDC1200 call.

STATUS SET (This function is only available in the VX-4600)

Press (or press and hold) the assigned programmable key to change the 5-tone status code. To change the status code, select the desired digit by pressing the [P1] key, then change the number by pressing the [P2]/[P3] key, and store the number by pressing the [P4] key.

You may enter the 5-tone status code directory from the microphone’s numeric key ([0] - [9]), if the optional **MH-75A8J** microphone is used.

ADVANCED OPERATION

STATUS UP/DOWN (This function is only available in the VX-4600)

Press (or press and hold) the assigned programmable key to select a 5-tone status code from the pre-defined status list.

STATUS CHECK (This function is only available in the VX-4600)

Press (or press and hold) the assigned programmable key to check the 5-tone receive status code. When you press this key, the display will indicate the “Message” corresponding to the receive status condition per the pre-defined status list.

DUTY

Press (or press and hold) the assigned programmable key to toggle the Duty function of the 2-tone/5-tone decoder “On” and “Off”.

When the Duty function is set to “On”, the user will always hear (depending on the sub-audio signaling) all traffic on the paging channel. The radio will sound the paging alert when it receives the programmed 2-tone/5-tone code.

When the Duty function is set to “Off”, the user will NOT hear normal radio traffic on the paging channel. The radio will sound the paging alert and unmute only when it receives the programmed 2-tone/5-tone code.

ID CHECK (This function is only available in the VX-4600)

This function allows logged ID of the DTMF Signaling and 5-tone Signaling to be reviewed and relayed (5-tone Signaling only) to a specific station:

- Press (or press and hold) the assigned programmable key to display the logged ID of the DTMF Signaling and 5-tone Signaling.
- Press the [P4] key to select the category (“DTMF Signaling” or “5-tone Signaling”) to be reviewed, then press the [▼]/[▲] keys to select the ID.
- Press the [P2] key to toggle the display between the “ID code display” and “Tag display”.
- Press the [P1] key to send the Call back, when recalling the ID of the “5-tone Signaling”, if desired.

OPTION SWITCH 1



Activates the optional accessory “1” while pressing the assigned programmable key.

ADVANCED OPERATION

OPTION SWITCH 2

Press the assigned programmable key to toggle the optional accessory “2” “On” and “Off”.

REC (REQUIRES THE DVS-8 VOICE STORAGE UNIT)

Press (or press and hold) the assigned programmable key to enable the Voice Recording Mode. When an incoming signal is received (the squelch opens and audio passes), the incoming audio will be recorded. The “” icon will flash during audio recording, and the “” icon will remain on once recording is complete.

PLAY (REQUIRES THE DVS-8 VOICE STORAGE UNIT)

Press (or press and hold) the assigned programmable key to play back the last message.

Press (or press and hold) the assigned programmable key again to stop the playback.

While playback is proceeding, you may press the [P1] key (or MH-75A8J’s [A] key) to jump to the previous message, or press the [P2] key (or MH-75A8J’s [B] key) to jump to the next message. Furthermore, press the [P4] key (or MH-75A8J’s [D] key) to delete all messages and stop the play-back.

TX SAVE DISABLE

Press (or press and hold) the assigned programmable key to disable the Transmit Saver, if you are operating in a location where high power is almost always needed.

The Transmit Saver reduces the transmit power when a very strong signal from an apparently nearby station is being received.

LOCK

Press (or press and hold) the assigned programmable key to lock the various aspects of the front panel’s keys. The precise lockout configuration must be programmed by your Vertex Standard dealer.

ADVANCED OPERATION

ARTS™ (Auto Range Transpond System)

This system is designed to inform you when you and another ARTS™-equipped station are within communication range.

During ARTS™ operation, when the radio receives an incoming ARTS™ signal, a short beep will sound, and “IN SERV” (“In Service”) will be indicated on the display for 2 seconds*. If you move out of range for more than two minutes, your radio senses that no signal has been received; a short triple-beep will sound, and “OUT SERV” (“Out of Service”) will be displayed on the display for 2 seconds*. If you subsequently move back into communication range, as soon as the other station transmits, a short beep will sound and “IN SERV” will be indicated again on the display for 2 seconds*.

※: The **VX-4600** only.

USER SET MODE

The **VX-4600** includes a “User Set” (Menu) Mode which allows the user to define or configure various settings, such as Squelch, Display contrast, etc. To activate the “User Set” (Menu) Mode:

- Press the programmable key assigned to the “**SET**” function.
- Select the User Set Mode item you wish to change using the [**P1**]/[**P2**] keys, then use the [**▼**]/[**▲**] keys to adjust the setting of the selected item.
- Press the [**P4**] key to store the new configuration.
You may cancel the selection by pressing the [**P3**] key.
- Press the programmable key assigned to the “**SET**” function to exit to normal operation.

DISPLAY	DESCRIPTION
SQL	Sets the Squelch level.
Beep	Enables/Disables the Key Beeper.
Bell	Enables/Disables the Bell function. (alert tone activated by incoming signaling)
Light	Enables/Disables the back light of the display and keypad.
Key	Enables/Disables the Key Lock function.
PTT	Enables/Disables the PTT Lock function.
DIMMER	Sets the LCD Brightness level.
Scan	Engages/Disengages Scanning.
DW	Engages/Disengages Dual Watch.
AF	Sets the minimum Audio Volume level.
CONTRAST	Sets the LCD Contrast level.
VOX	Sets the VOX Gain level.
Encryption	Enables/Disables the disabling the Encryption Unit temporarily. ENB: Enables the disabling the Encryption Unit. DIS: Disables the disabling the Encryption Unit.
TX Save	Enables/Disables the TX Save function.
REC*	Select the Recording mode. ONE: Enables one-shot recording of audio for 120 seconds, with playback from beginning of the message. ROL: Enables rolling recording so long as the receiver is passing audio, with playback of the last 120 seconds recorded.
PLAY*	Select the priority system audio during recorder playback. PLAY: The recorded audio is higher priority than the received signals audio. SIG: The received signal’s audio is higher priority than the playback audio.

Note: The Menu item “REC” and “PLAY” will appear only when the optional **DVS-8** Voice Storage Unit is installed.

OPTIONAL ACCESSORIES

MH-67A8J	Standard Microphone
MH-75A8J	16-Keypad Microphone
MLS-100	External Speaker (12 W Peak Power)
MLS-200	External Speaker (15 W Peak Power)
FP-1023A	External Power Supply (13.8 VDC 23 A)
DVS-8	Voice Storage Unit
LF-6	Line Filter
CE115	PC Programming Software
CT-4	Programming Cable (Radio to Radio Clone Cable)
VPL-1	Programming Kit (Computer to PC)
FIF-10A	USB Programming Interface
CT-104A	Connection Cable for FIF-10A (8-pin DIN ↔8-pin Modular)

Availability of accessories may vary; some accessories are supplied standard per local requirements, others may be unavailable in some regions.

Check with your VERTEX STANDARD Dealer for changes to this list.

NOTE

NOTE

NOTE

NOTICE !

There are no owner-serviceable parts inside the transceiver. All service jobs must be referred to an authorized Vertex Standard Service Representative. Consult your Authorized Vertex Standard Dealer for installation of optional accessories.

Part 15.21: Changes or modifications to this device not expressly approved by Vertex Standard could void the user's authorization to operate this device.



Declaration of Conformity

We, YAESU UK LTD. declare under our sole responsibility that the following equipment complies with the essential requirements of the Directive 1999/5/EC and 2004/104/EC.

Type of Equipment:	FM Transceiver
Brand Name:	VERTEX STANDARD
Model Number:	VX-4500/-4600 Series
Manufacturer:	Vertex Standard Co., Ltd.
Address of Manufacturer:	4-8-8 Nakameguro Meguro-Ku, Tokyo 153-8644, Japan

Applicable Standards:

This equipment is tested and conforms to the essential requirements of directive, as included in following standards.

Radio Standard:	EN 300 086-2 V1.3.1
	EN 300 113-2 V1.4.2
EMC Standard:	EN 301 489-01 V1.8.1
	EN 301 489-05 V1.3.1
Safety Standard:	EN 60950-1: 2006 +A1: 2010

The technical documentation as required by the Conformity Assessment procedures is kept at the following address:

Company: YAESU UK LTD.
Address: Unit 12, Sun Valley Business Park, Winnall Close
Winchester, Hampshire, SO23 0LB, U.K.

DISPOSAL OF YOUR ELECTRONIC AND ELECTRIC EQUIPMENT

Products with the symbol (crossed-out wheeled bin) cannot be disposed as household waste.



Electronic and Electric Equipment should be recycled at a facility capable of handling these items and their waste byproducts.

In EU countries, please contact your local equipment supplier representative or service center for information about the waste collection system in your country.

ATTENTION IN CASE OF USE

This transceiver works on frequencies which are not generally permitted.

For frequency allocation, apply for a licence at your local spectrum management authority.

For actual usage contact your dealer or sales shop in order to get your transceiver adjusted to the allocated frequency range.

List of the practicable area						
AUT	BEL	BGR	CYP	CZE	DEU	
DNK	ESP	EST	FIN	FRA	GBR	
GRC	HUN	IRL	ITA	LTU	LUX	
LVA	MLT	NLD	POL	PRT	ROM	
SVK	SVN	SWE	CHE	ISL	LIE	
NOR						



VERTEX STANDARD CO., LTD.

4-8-8 Nakameguro, Meguro-Ku, Tokyo 153-8644, Japan

VERTEX STANDARD

US Headquarters

10900 Walker Street, Cypress, CA 90630, U.S.A.

YAESU UK LTD.

Unit 12, Sun Valley Business Park, Winnall Close
Winchester, Hampshire, SO23 0LB, U.K.

VERTEX STANDARD HK LTD.

Unit 1306-1308, 13F., Millennium City 2, 378 Kwun Tang Road,
Kwun Tong, Kowloon, Hong Kong

VERTEX STANDARD (AUSTRALIA) PTY., LTD.

Tally Ho Business Park, 10 Wesley Court, East Burwood, VIC, 3151

Copyright 2011

VERTEX STANDARD CO., LTD.

All rights reserved.

No portion of this manual

may be reproduced

without the permission of

VERTEX STANDARD CO., LTD.

Printed in China



E C 0 9 3 U 1 0 1