

ASTRO®

MT 1500

Model 1

User Guide



MT 1500

Portable Radio

Quick Reference Card

Product Safety and RF Exposure Compliance



Before using this product, read the operating instructions for safe usage contained in the Product Safety and RF Exposure booklet enclosed with your radio.

ATTENTION!

This radio is restricted to occupational use only to satisfy FCC RF energy exposure requirements. Before using this product, read the RF energy awareness information and operating instructions in the Product Safety and RF Exposure booklet enclosed with your radio (Motorola Publication part number 6881095C98) to ensure compliance with RF energy exposure limits.

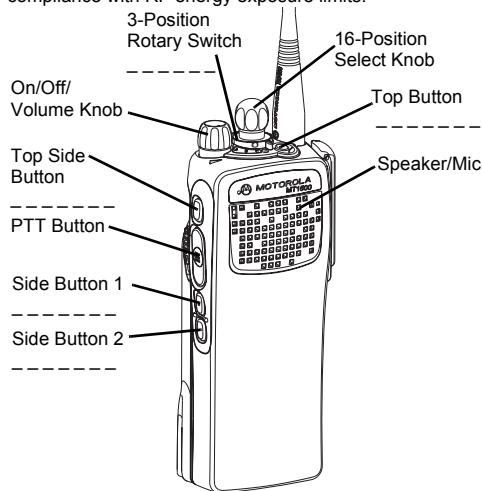

Write your radio's programmed features on the dashed lines.

Radio On/Off

- 1 On - On/Off/Volume knob clockwise.
- 2 Off - On/Off/Volume knob counterclockwise.

Zones/Channels

- 1 Zone - Move **Zone** switch to desired zone.
- 2 Channel - Turn **Channel Selector** switch to desired channel.

Receive/Transmit

- 1 Radio on and select zone/channel.
OR
Press and hold **Volume Set** button. Release **Volume Set** button.
OR
Press **Monitor** button and listen for activity.
- 3 Adjust volume, if necessary.
- 4 Press and hold **PTT** to transmit; release to listen.

Send Emergency Alarm

- 1 Radio on and press **Emergency** button. You see red LED; you hear short, medium-pitched tone.

- 2 When dispatcher's acknowledgment is received, you hear four tones; alarm ends; radio exits emergency.

Send Silent Emergency Alarm

- 1 Radio on and press **Emergency** button. You see no LED; you hear no tone.
- 2 Press **PTT**.
- 3 Alarm continues until you exit by:
 - Press and hold **Emergency** button for one second**OR**
 - Press and release **PTT**.

Send Emergency Call

- 1 Radio on and press **Emergency** button. A short, medium-pitched tone sounds.
- 2 Press and hold **PTT**. Announce your emergency into the microphone.
- 3 Release **PTT** to end call.
- 4 Press and hold **Emergency** button for one second to exit.

This declaration is applicable to your radio *only* if your radio is labeled with the FCC logo shown below.

DECLARATION OF CONFORMITY

Per FCC CFR 47 Part 2 Section 2.1077(a)



Responsible Party

Name: Motorola, Inc.

Address: 1301 E. Algonquin Rd, Schaumburg, IL 60196-1078 USA

Phone Number: 1-800-927-2744

Hereby declares that the product:

Model Name: **MT 1500I**

conforms to the following regulations:

FCC Part 15, subpart B, section 15.107(a), 15.107(d) and section 15.109(a)

Class B Digital Device

As a personal computer peripheral, this device complies with Part 15 of the FCC Rules. Operation is subject to the following two conditions:

1. this device may not cause harmful interference, and
2. this device must accept any interference received, including interference that may cause undesired operation.

Note: This equipment has been tested and found to comply with the limits for a Class B digital device, pursuant to part 15 of the FCC Rules. These limits are designed to provide reasonable protection against harmful interference in a residential installation. This equipment generates, uses and can radiate radio frequency energy and, if not installed and used in accordance with the instructions, may cause harmful interference to radio communications. However, there is no guarantee that interference will not occur in a particular installation.

If this equipment does cause harmful interference to radio or television reception, which can be determined by turning the equipment off and on, the user is encouraged to try to correct the interference by one or more of the following measures:

- Reorient or relocate the receiving antenna.
- Increase the separation between the equipment and receiver.
- Connect the equipment into an outlet on a circuit different from that to which the receiver is connected.
- Consult the dealer or an experienced radio/TV technician for help.

Product Safety and RF Exposure Compliance

 Caution	Before using this product, read the operating instructions for safe usage contained in the Product Safety and RF Exposure booklet enclosed with your radio.
--	--

ATTENTION!

This radio is restricted to occupational use only to satisfy FCC RF energy exposure requirements. Before using this product, read the RF energy awareness information and operating instructions in the Product Safety and RF Exposure booklet enclosed with your radio (Motorola Publication part number 6881095C98) to ensure compliance with RF energy exposure limits.

For a list of Motorola-approved antennas, batteries, and other accessories, visit the following web site which lists approved accessories: <http://www.motorola.com/governmentandenterprise>

Computer Software Copyrights

The Motorola products described in this manual may include copyrighted Motorola computer programs stored in semiconductor memories or other media. Laws in the United States and other countries preserve for Motorola certain exclusive rights for copyrighted computer programs, including, but not limited to, the exclusive right to copy or reproduce in any form the copyrighted computer program. Accordingly, any copyrighted Motorola computer programs contained in the Motorola products described in this manual may not be copied, reproduced, modified, reverse-engineered, or distributed in any manner without the express written permission of Motorola. Furthermore, the purchase of Motorola products shall not be deemed to grant either directly or by implication, estoppel, or otherwise, any license under the copyrights, patents or patent applications of Motorola, except for the normal non-exclusive license to use that arises by operation of law in the sale of a product.

Documentation Copyrights

No duplication or distribution of this document or any portion thereof shall take place without the express written permission of Motorola. No part of this manual may be reproduced, distributed, or transmitted in any form or by any means, electronic or mechanical, for any purpose without the express written permission of Motorola.

Disclaimer

The information in this document is carefully examined, and is believed to be entirely reliable. However, no responsibility is assumed for inaccuracies. Furthermore, Motorola reserves the right to make changes to any products herein to improve readability, function, or design. Motorola does not assume any liability arising out of the applications or use of any product or circuit described herein; nor does it cover any license under its patent rights, nor the rights of others.

Contents

Product Safety and RF Exposure Compliance	ii
Computer Software Copyrights	ii
Documentation Copyrights	ii
Disclaimer	iii
General Radio Operation	1
Notations Used in This Manual	1
MT 1500 Radio	2
Physical Features of the MT 1500 Radio	3
Programmable Features	3
LED Indicators	5
Alert Tones	5
Standard Accessories	9
Battery	9
Antenna	11
Belt Clip	12
Universal Connector Cover	13
Remove the Connector Cover	13
Attach the Connector Cover	13
Remote Speaker Microphone Adapter	14
Remove the Adapter	14
Attach the Adapter	14
Radio On and Off	15
Turn the Radio On	15
Turn the Radio Off	15
Zones and Channels	16
Select a Zone	16
Select a Channel	16
Mode Select Button	17
Receive / Transmit	18
Without Using the Volume Set and Monitor Buttons	18
Use the Preprogrammed Volume Set Button	19
Use the Preprogrammed Monitor Button	20
Conventional Mode Operation	21
Common Radio Features	23
Conventional Squelch Options	23
Analog Squelch	23

PL Defeat	23
Time-out Timer	24
Emergency	25
Send an Emergency Alarm	26
Send a Silent Emergency Alarm	27
Send an Emergency Call	27
Emergency Keep-Alive	29
Scan	30
Turn Scan On and Off	30
Delete a Nuisance Channel	30
Telephone Calls (Trunking Only)	31
Answer a Phone Call	31
Private Calls (Trunking Only)	32
Answer a Private Call	32
Call Alert Paging	33
Answer a Call Alert Page	33
Repeater or Direct Operation	34
Select Repeater or Direct Operation	34
Mute	34
Special Radio Features	35
Trunking System Controls	35
Failsoft	35
Out-of-Range	35
Site Lock	36
Site Change	36
Helpful Tips	37
Radio Care	37
Cleaning	37
Handling	37
Service	38
Battery	39
Battery Life	39
Charging the Battery	39
Battery Recycling and Disposal	40
Antenna	41
Radio Operating Frequencies	41

Accessories	43
Antennas	43
Batteries	44
Carry Accessories	44
Belt Clips	44
Body-Worn	44
Chargers	45
Enhanced and Multi-Unit Line Cords	45
Microphones, Remote Speaker	46
Surveillance Accessories	46
Earpieces	46
Headsets and Headset Accessories	48
Radio Interface Modules for Ear Microphones	48
Switches	48
Appendix: Maritime Radio Use in the VHF Frequency Range	49
Special Channel Assignments	49
Emergency Channel	49
Non-Commercial Call Channel	50
Operating Frequency Requirements	50
Glossary	53
Commercial Warranty	57
Index	62

Table 1: Channel Map

Use the chart below to map the channels (Cx) and zones (Zx) for your radio.

	Z1	Z2	Z3
C1			
C2			
C3			
C4			
C5			
C6			
C7			
C8			
C9			
C10			
C11			
C12			
C13			
C14			
C15			
C16			

General Radio Operation

Notations Used in This Manual

You will notice the use of **WARNING**, **CAUTION**, and **Note** notations throughout this manual. These notations are used to emphasize that safety hazards exist and that care must be taken or observed.



An operational procedure, practice, condition, etc. exists which may result in injury or death if not carefully observed.



An operational procedure, practice, condition, etc. exists which may result in damage to the equipment if not carefully observed.

Note: An operational procedure, practice, or condition, etc. which is essential to emphasize.

The following special notations identify certain items:

<i>Example</i>	<i>Description</i>
Top button	Buttons are shown in bold print.

MT 1500 Radio

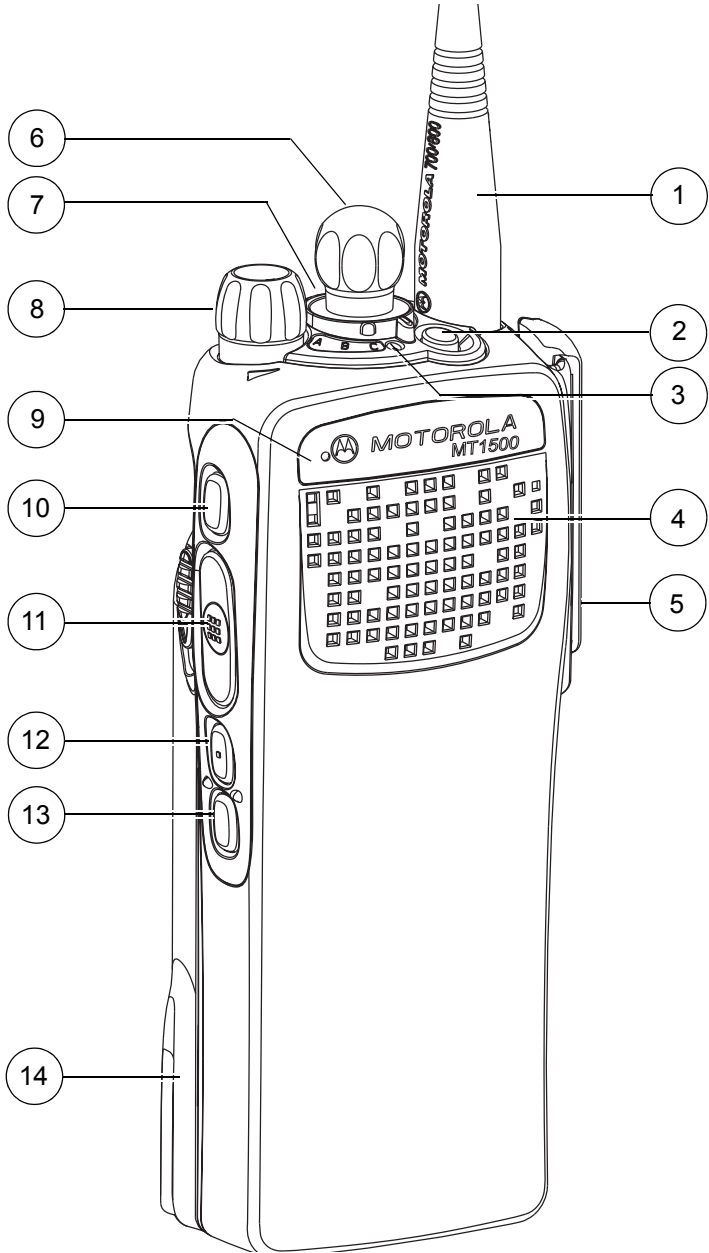

Physical Features of the MT 1500 Radio

<i>Item</i>	<i>Page</i>	<i>Item</i>	<i>Page</i>
1 Antenna	11	8 On/Off/Volume Control Knob	15
2 Top Button (programmable)		9 Microphone	
3 LED	5	10 Top Side (Select) Button (programmable)	
4 Speaker		11 Push-to-Talk (PTT) Button	
5 Universal Connector	13	12 Side Button 1 (programmable)	
6 16-Position Knob (programmable)		13 Side Button 2 (programmable)	
7 3-Position Concentric Switch (programmable)		14 Battery	9

Programmable Features

The programmable controls on your radio can be programmed by a qualified technician to operate certain software-activated features. The features that can be assigned to these controls, and the page numbers where these features can be found, are listed below.

Table 1: Programmable Features

<i>Feature</i>	<i>Page</i>	<i>Feature</i>	<i>Page</i>
Call Response	31	PL Defeat	23
Channel Selection	16	Repeater/Direct	34
Emergency	25	Scan On/Off	30
Monitor	20	Site Lock/Unlock	36
Mute	34	Site Search	36
Nuisance Delete	30	Volume Set	19

Table 1: Programmable Features

<i>Feature</i>	<i>Page</i>	<i>Feature</i>	<i>Page</i>
Phone	31	Zone Selection	16

Any references in this manual to controls that are “preprogrammed” means that a qualified radio technician must use the radio’s programming software to assign a feature to a control.

LED Indicators

Table 2: LED Indicators

<i>This LED Color:</i>	<i>indicates:</i>
RED (Non-blinking)	Transmitting
RED (Blinking)	<ul style="list-style-type: none"> • Channel Busy OR <ul style="list-style-type: none"> • Low Battery (lights while transmitting)
GREEN (Blinking)	Receiving Individual Call
GREEN (Blinking)	Scan is activated.

Alert Tones

Your radio uses alert tones to inform you of radio conditions.

Table 3: Alert Tones

<i>You hear:</i>	<i>Tone Name</i>	<i>Heard:</i>
<i>Short, Low-Pitched Tone</i>	Invalid Key-Press	when the wrong key is pressed.
	Radio Self-Test Failed	when the radio fails the power-up self test.
	Reject	when an unauthorized request is made.
	Time-Out Timer Warning	four seconds before time out.

Table 3: Alert Tones (Continued)

<i>You hear:</i>	<i>Tone Name</i>	<i>Heard:</i>
<i>Long, Low-Pitched Tone</i>	No ACK Received	when the radio does not receive an acknowledgment.
	Time-Out Timer Timed Out	after time out.
	Talk Prohibit/ PTT Inhibit	when the PTT button is pressed, and transmissions are prevented.
	Out-of-Range	when the PTT button is pressed, but the radio is out of range of the system.
	Invalid Mode	when the radio is set to an unprogrammed channel.
	Individual Call Warning Tone	when the radio is in Individual Call without any activity for more than 6 seconds.
<i>A Group of Low-Pitched Tones (Busy Tone)</i>	Busy	when the system is busy.
<i>Short, Medium- Pitched Tone</i>	Valid Key-Press	when the correct key is pressed.
	Radio Self-Test Pass	when the radio passes its power-up self-test.
	Priority Channel Received	when activity on a priority channel is received.
	Emergency Alarm Entry	when entering the emergency state.
	Central Echo	when the central controller has received a request from a radio.

Table 3: Alert Tones (Continued)

You hear:	Tone Name	Heard:
<i>Long, Medium- Pitched Tone</i>	Volume Set	when volume changed on a quiet channel.
	Emergency Exit	upon exiting the emergency state.
<i>A Group of Medium- Pitched Tones</i>	Failsoft	when the trunking system fails.
	Automatic Call Back	when the voice channel is available from the previous request.
	Talk Permit	(When pressing the PTT button) verifies the system is accepting transmissions.
	Console Acknowledge	when a status, emergency alarm, or reprogram request acknowledgment is received.
	Received Individual Call	when a Call Alert, or Private Conversation Call is received.
<i>A Group of Low Pitched Tones followed by a group of High Pitched Tones</i>	Scan Alert On	when the Scan feature is activated through the pre-programmed button or 3-Position Rotary Switch
<i>A Group of High Pitched Tones followed by a group of Low Pitched Tones</i>	Scan Alert Off	when the Scan feature is deactivated through the pre-programmed button or 3-Position Rotary Switch

Table 3: Alert Tones (Continued)

<i>You hear:</i>	<i>Tone Name</i>	<i>Heard:</i>
<i>Short, High-Pitched Tone (Chirp)</i>	Low-Battery Chirp	when the battery is below the preset threshold value.
<i>Ringling</i>	Phone Call Received	when a landline phone call is received.

Standard Accessories

Battery



To avoid a possible explosion:

- **DO NOT** replace the battery in any area labeled “hazardous atmosphere”.
- **DO NOT** discard batteries in a fire.

Charge the Battery

The Motorola approved battery shipped with your radio is uncharged. Prior to using a new battery, charge it for a minimum of 16 hours to ensure optimum capacity and performance.

For a list of Motorola approved batteries available for use with your MT 1500 radio, see “Batteries” on page 44.

Note: When charging a battery attached to a radio, turn the radio off to ensure a full charge.

Battery Charger

To charge the battery, place the battery, with or without radio, in a Motorola-approved charger. The charger’s LED indicates the charging progress; see your charger’s user guide. For a list of chargers, see “Chargers” on page 45.

Attach the Battery

- 1 With the radio off, fit the three extensions at the bottom of the battery into the bottom slots on the radio.

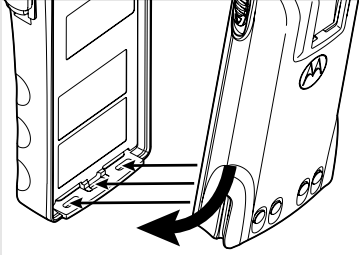

- 2 Press the top of the battery against the radio until both latches click into place.

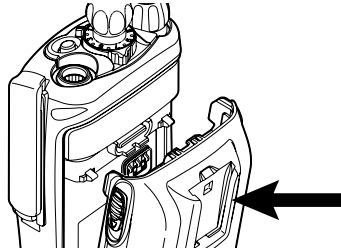

Remove the Battery

- 1 With the radio off, slide down the latches on the sides of the battery.

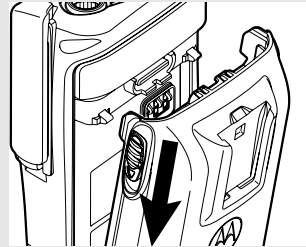

- 2 Pull the top of the battery away from the radio.

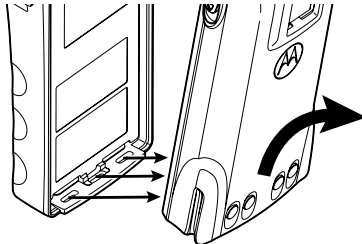

Antenna

For information regarding other available antennas, see page 43.

Attach the Antenna

With the radio off, turn the antenna clockwise to attach it.



Remove the Antenna

With the radio off, turn the antenna counter-clockwise to remove it.

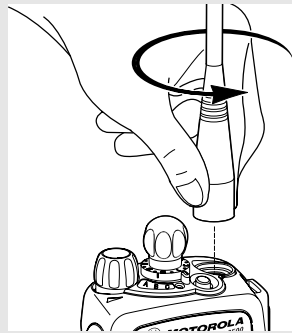

Belt Clip

Attach the Belt Clip

- 1 Align the grooves of the belt clip with those of the battery.

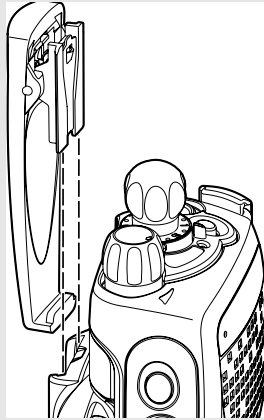

- 2 Press the belt clip downward until you hear a “click.”

Remove the Belt Clip

- 1 Use a flat-bladed object to press the belt clip tab away from the battery.

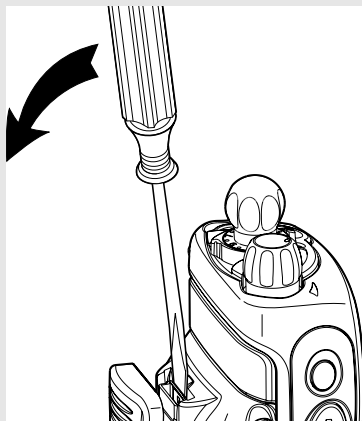

- 2 Slide the belt clip upward to remove it.
-

Universal Connector Cover

The universal connector cover is located on the antenna side of the radio. It is used to connect certain accessories to the radio.

Note: To prevent damage to the connector, shield it with the connector cover when not in use.

Remove the Connector Cover

- 1 Insert a flat-bladed screwdriver into the area between the bottom of the cover and the slot below the connector.
- 2 Hold the top of the cover with your thumb while you pry the bottom of the cover away from the radio with the screwdriver.

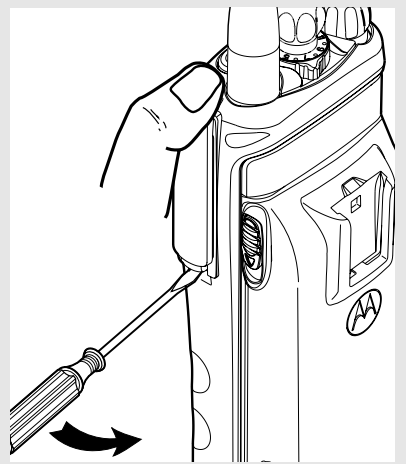

Attach the Connector Cover

- 1 Insert the hooked end of the cover into the top of the connector. Press downward on the cover's top to seat it into the slot.
- 2 Press the cover's lower tab below the connector until it snaps in place.

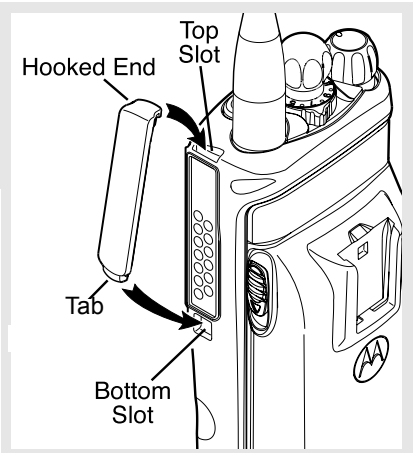

Remote Speaker Microphone Adapter

The Remote Speaker Microphone (RSM) adapter is located on the back of the radio, just above the battery. **It must be used to connect the RSM accessories (see page 46) to the radio.** If the RSM is not used, the adapter should be removed.

Remove the Adapter

Lift the larger side (below the antenna port) of the adapter away from the radio using your finger.

If you cannot easily remove the adapter with your finger, use a small, flat blade screwdriver to pry the larger end side of the adapter away from the radio.

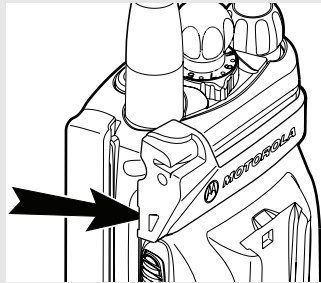

Attach the Adapter

- 1 With the Motorola side of the adapter facing out, snap the smaller end of the adapter into place in the shroud indent, below the **On/Off Volume Control Knob**.

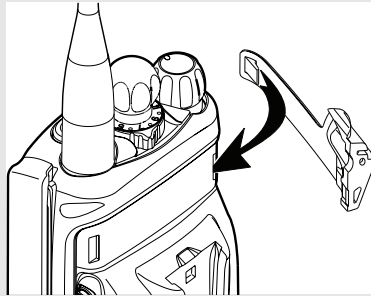

- 2 Snap the larger end of the adapter into place in the shroud indent, below the antenna port.

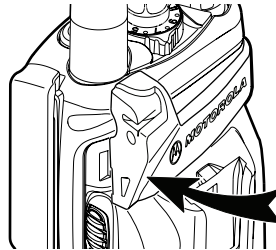

Radio On and Off

Turn the Radio On

Turn the **On/Off/Volume Control** knob clockwise.

- If the test is successful, you hear a medium-pitched tone.
- If the test is unsuccessful, you hear a low-pitched tone. Turn off the radio, check the battery, and turn the radio on.

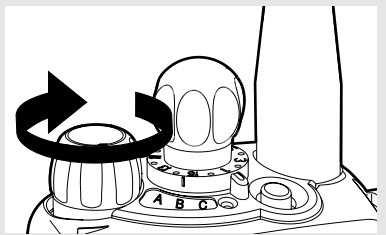

Turn the Radio Off

Turn the **On/Off/Volume Control** knob counterclockwise until it clicks.

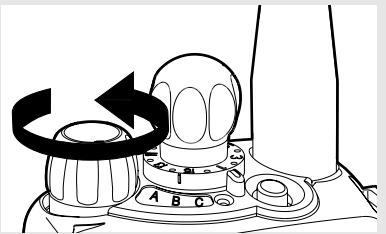

Zones and Channels

A zone is a grouping of channels. A channel is a group of radio characteristics, such as transmit/receive frequency pairs.

Before you use your radio to receive or send messages, you should select the zone.

Select a Zone

- 1 If a control on your radio has been preprogrammed as the **Zone** switch, move the **Zone** switch to the position for the zone you want.
- 2 If the zone you selected is unprogrammed, you hear a long, medium-pitched tone until you select a programmed zone.
 - Long, medium-pitched tone

Select a Channel

- 1 After you selected the zone you want, turn the preprogrammed **Channel Selector** switch to the desired channel.
- 2 If the channel you selected is unprogrammed, you hear a long, medium-pitched tone until you select a programmed channel.
 - Long, medium-pitched tone

Mode Select Button

This feature lets you program the current zone and channel to a **Mode Select** button with a long press on the **Mode Select** button. After the buttons are programmed, you can return to the pre-programmed zone and channel with a short press on the programmed **Mode Select** button.

The buttons that are assigned for this feature are labeled in the following picture.

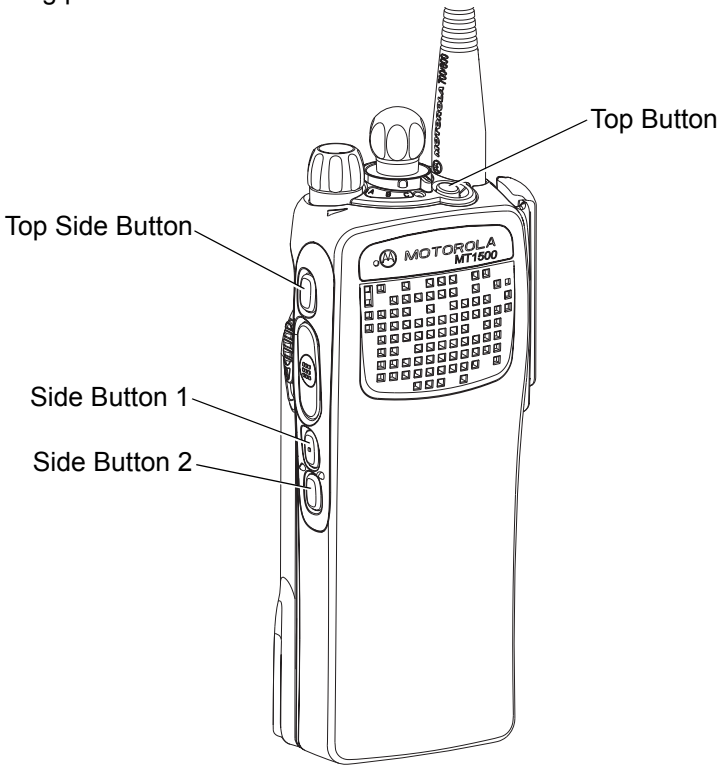

Receive / Transmit

This section emphasizes the importance of knowing how to monitor a channel for traffic before keying-up to send a transmission.

Without Using the Volume Set and Monitor Buttons

- 1 Turn the radio on and select the desired zone and channel.
- 2 Listen for a transmission.
- 3 Adjust the **Volume Control** knob if necessary.

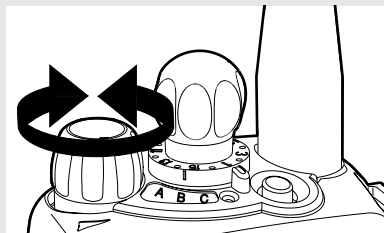

- 4 Press and hold the **PTT** button to transmit. The LED lights RED while transmitting.
- 5 Release the **PTT** button to receive (listen).

Use the Preprogrammed Volume Set Button

- 1 Turn the radio on and select the desired zone and channel. See **Turn the Radio On**, page 15 and **Zones and Channels**, page 16.
- 2 Press and hold the **Volume Set** button to hear the volume set tone.
- 3 Release the **Volume Set** button.
- 4 Adjust the **Volume Control** Knob if necessary.

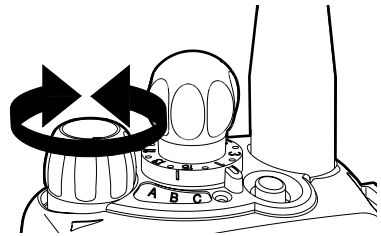

- 5 Press and hold the **PTT** button to transmit. LED lights RED while transmitting.
 - 6 Release the **PTT** button to receive (listen).
-

Use the Preprogrammed Monitor Button

- 1 Turn the radio on and select the desired zone and channel.
- 2 Press the Monitor button and listen for activity. (See the following **Conventional Mode Operation.**)
- 3 Adjust the **Volume Control** knob if necessary.

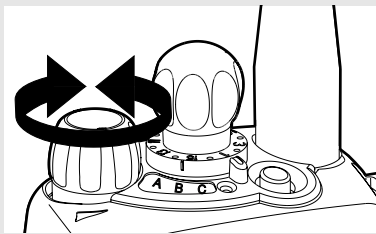

- 4 Press and hold the **PTT** button to transmit. The LED lights RED while transmitting.
- 5 Release the **PTT** button to receive (listen).

Conventional Mode Operation

Your radio may be programmed to receive Private-Line® (PL) calls.

- 1** Momentarily press the **Monitor** button to listen for activity.
- 2** Press and hold the **Monitor** button to set continuous monitor operation. (The duration of the button press is programmable.)
- 3** Press the **Monitor** button again, or the **PTT** button, to return to the original squelch setting.

Note: If you try to transmit on a receive-only channel, you will hear an invalid tone until you release the **PTT** button.

Notes

Common Radio Features

Conventional Squelch Options

Analog Squelch

Tone Private Line (PL) and carrier squelch can be available (preprogrammed) per channel.

When in...	this condition occurs:
Carrier squelch	You hear all traffic on a channel.
PL	The radio responds only to your messages.

PL Defeat

With this feature, you can override any coded squelch (PL or network ID) that might be programmed to a channel.

Place the preprogrammed **PL Defeat** switch in the **PL Defeat** position. You can now hear any activity on the channel. The radio is muted if no activity is present.

Time-out Timer

The time-out timer turns off your radio's transmitter. The timer is set for 60 seconds at the factory, but it can be programmed from 0 to 7.75 minutes (465 seconds) by a qualified radio technician.

- | | |
|---|---|
| 1 Hold down the PTT longer than the programmed time. You will hear a short, low-pitched warning tone, the transmission is cut-off, and the LED will go out until you release the PTT . | <ul style="list-style-type: none">• Short warning tone• Transmission is cut-off• LED goes out |
| 2 Release the PTT button. | <ul style="list-style-type: none">• LED re-lights• Timer resets |
| 3 Press the PTT to re-transmit. Time-out timer restarts. | <ul style="list-style-type: none">• Timer restarts• RED LED |

Emergency

If the top (orange) button is programmed to send an emergency signal, then this signal overrides any other communication over the selected channel.

Your radio can be programmed for the following:

- Emergency Alarm
- Emergency Alarm with Emergency Call
- Silent Emergency Alarm
- Emergency Call

Consult a qualified radio technician for emergency programming of your radio.

Send an Emergency Alarm

An Emergency Alarm will send a data transmission to the dispatcher, identifying the radio sending the emergency.

- | | |
|---|--|
| 1 With your radio turned on, press the Emergency button. The red LED lights, and you hear a short, medium-pitched tone. | <ul style="list-style-type: none">• Red LED• Short tone |
|---|--|

Note: To exit emergency at any time, press and hold the **Emergency** button for about a second.

- | | |
|---|---|
| 2 When you receive the dispatcher's acknowledgment, you hear four tones, the alarm ends, and the radio exits the emergency mode. | <ul style="list-style-type: none">• Four tones• Alarm ends• Radio exits emergency |
|---|---|

If no acknowledgement is received, the alarm ends after the number of retries is performed, and the radio exits the emergency mode.

- Alarm ends
- Radio exits emergency

Note: For Emergency Alarm with Emergency Call: The radio enters the Emergency Call state either after it receives the dispatcher's acknowledgment, or if you press the **PTT** button while in Emergency Alarm. Go to step 2 of "Send an Emergency Call" on page 27.

Send a Silent Emergency Alarm

- 1 With your radio turned on, press the **Emergency** button. The LED does not light, and you hear no tones.
 - LED does not light
 - No tones

Note: To exit emergency at any time, press and hold the **Emergency** button for about a second.

- 2 The silent emergency state continues until you:

Press and hold the **Emergency** button for about a second to exit the emergency state.

- Press and hold **Emergency** button

OR

Press and release the **PTT** button to exit silent emergency and enter regular dispatch or emergency call.

OR

- Press and release the **PTT** button

Send an Emergency Call

An Emergency Call will send a type of dispatch giving your radio priority access to channels.

- 1 With your radio turned on, press the **Emergency** button. A short, medium-pitched tone sounds.
 - Short tone

Note: To exit emergency at any time, press and hold the **Emergency** button.

- 2 Press and hold the **PTT** button and announce your emergency into the microphone.

- 3 Release the **PTT** button to end the transmission and wait for a response from the dispatcher.
 - 4 Press and hold the **Emergency** button for about a second to exit emergency.
-

The radio operates in the normal dispatch manner while in Emergency Call, except, if enabled, it will return to one of the following:

<i>Using this operation:</i>	<i>means you will talk...</i>
1. Tactical/Non-Revert	on the channel you selected before you entered the emergency state.
2. Non-Tactical/Revert	on a preprogrammed emergency channel. The emergency alarm is sent to this same channel.

Note: For ALL Emergency signals:

- You can change channels while in Emergency operation if the new channel is also programmed for Emergency. The emergency alarm or call continues on the new channel.
- If the new channel is NOT programmed for Emergency, an invalid tone sounds until you exit the Emergency state or change to a channel programmed for emergency.

Emergency Keep-Alive

With Emergency Keep-Alive enabled, if the radio is in the Emergency state, you cannot turn off the radio by using the **On/Off Volume Control** knob.

With Keep-Alive, the radio will only exit the Emergency state using one of the ways mentioned in the previous sections (Emergency Alarm, Silent Emergency Alarm, or Emergency Call).

Scan

The scan feature allows you to monitor traffic on different channels by scanning a preprogrammed list of channels. The list must be preprogrammed by a qualified technician.

Turn Scan On and Off

Use the Preprogrammed Scan On/Off Switch

Place the **Scan On/Off** Switch or Button in the “scan on” or “scan off” position.

Delete a Nuisance Channel

When the radio scans to a channel that you do not wish to hear (nuisance channel), you can temporarily delete the channel from the scan list.

- 1 When the radio is locked onto the channel to be deleted, press the preprogrammed **Nuisance Delete** button.

Repeat this step to delete more channels.

Note: You cannot delete priority channels or the designated transmit channel.

- 2 The radio continues scanning the remaining channels in the list. To resume scanning the deleted channel, change channels or turn scan off and then back on again.
-

Telephone Calls (Trunking Only)

Use your radio to receive standard phone calls. A landline phone can be used to call a radio.

Answer a Phone Call

Use the Preprogrammed Call Response Button

- 1** When a phone call is received you hear telephone-type ringing and the LED flashes GREEN.
 - Telephone-type ringing
 - LED flashes GREEN
 - 2** Press the **Call Response** or **Phone** button within 20 seconds after the call indicators begin.
 - 3** Press and hold the **PTT** button to talk; release it to listen.
 - 4** Press the **Call Response** button to hang up.
-

Private Calls (Trunking Only)

These one-to-one calls between two radios are not heard by others in the current talkgroup.

Answer a Private Call

Use the Preprogrammed Call Response Button.

- 1 When a private call is received you hear two alert tones and the LED flashes GREEN.
 - Two alert tones
 - LED flashes GREEN
 - 2 Press the preprogrammed **Call Response** button within 20 seconds.
 - 3 Press and hold the **PTT** button to talk; release it to listen.
 - 4 Press the **Call Response** button to hang up.
-

Call Alert Paging

Call Alert allows your radio to work like a pager.

Answer a Call Alert Page

- 1 When a Call Alert Page is received, you hear four repeating alert tones and the LED flashes GREEN.
 - Four repeating tones
 - LED flashes GREEN
 - 2 Press and hold the **PTT** button to talk, release it to listen.
-

Repeater or Direct Operation

Also known as TALKAROUND operation, DIRECT lets you bypass the repeater and connect directly to another radio. The transmit and receive frequencies are the same.

REPEATER operation increases the radio's range by connecting with other radios through a repeater. Transmit and receive frequencies are different.

Select Repeater or Direct Operation

Place the preprogrammed
Repeater/Direct switch in
Repeater or Direct position.

Mute

Mute is available on the Switches.

Special Radio Features

Trunking System Controls

Failsoft

The failsoft system ensures continuous radio communications during a trunked system failure. If a trunking system fails completely, the radio goes into failsoft operation, and automatically switches to its failsoft channel.

During failsoft operation:

- Your radio transmits and receives in conventional operation on a predetermined frequency.
- You hear a medium-pitched tone every 10 seconds.

When the trunking system returns to normal operation, your radio automatically leaves failsoft operation and returns to trunked operation.

Out-of-Range

If you go out of the range of the system, and can no longer lock onto a control channel, you hear a low-pitched tone.

Your radio remains in this out-of-range condition until

- It locks onto a control channel,
- It locks onto a failsoft channel, or
- It is turned off.

Site Lock

This feature allows your radio to lock onto a specific site and not roam among wide-area talkgroup sites. This feature should be used with caution, since it inhibits roaming to another site in a wide-area system.

Lock or Unlock a Site

- Press the preprogrammed **Site Lock/Unlock** button.
- The site lock state changes.

Site Change

You can force your radio to change to a new site.

Change the Current Site

- 1 Press and hold down the preprogrammed **Site Search** button to manually force the change to a new site. You hear a tone while the radio scans for a new site.
 - Tone sounds
 - 2 When the radio finds a new site, the tone stops.
 - Tone stops
-

Helpful Tips

Radio Care

Cleaning

To clean the external surfaces of your radio:

- 1 Combine one teaspoon of mild dishwashing detergent to one gallon of water (0.5% solution).
- 2 Apply the solution sparingly with a stiff, non-metallic, short-bristled brush, making sure excess detergent does not get entrapped near the connectors, controls or crevices. Dry the radio thoroughly with a soft, lint-free cloth.
- 3 Clean battery contacts with a lint-free cloth to remove dirt or grease.



Caution

Do not use solvents to clean your radio. Spirits may permanently damage the radio housing.

Do not submerge the radio in the detergent solution.

Handling

- Do not pound, drop, or throw the radio. Never carry the radio by the antenna.
- Avoid subjecting the radio to an excess of liquids.
- Avoid subjecting the radio to corrosives, solvents or spirits.
- Do not disassemble the radio.
- Keep the accessory-connector cover in place until ready to use the connector. Replace the cover immediately once the accessory has been disconnected.

Service

Proper repair and maintenance procedures will assure efficient operation and long life for this product. A Motorola maintenance agreement will provide expert service to keep this and all other communication equipment in perfect operating condition. A nationwide service organization is provided by Motorola to support maintenance services. Through its maintenance and installation program, Motorola makes available the finest service to those desiring reliable, continuous communications on a contract basis. For a contract service agreement, please contact your nearest Motorola service or sales representative, or an authorized Motorola dealer.

Express Service Plus (ESP) is an optional extended service coverage plan, which provides for the repair of this product for a period of three years from the date of shipment from the factory, or the date of delivery if purchased from an authorized Motorola two-way radio dealer. For more information about ESP, contact the Motorola Radio Support Center, 2204 Galvin Drive, Elgin, IL 60123, 1-800-227-6772.

Battery

Battery Life

Battery life is determined by several factors. Among the more critical are the regular overcharge of batteries and the average depth of discharge with each cycle. Typically, the greater the overcharge and the deeper the average discharge, the fewer cycles a battery will last. For example, a battery which is overcharged and discharges 100% several times a day, will last fewer cycles than a battery that receives less of an overcharge and is discharged to 50% per day. Further, a battery which receives minimal overcharging and averages only 25% discharge, will last even longer.

Charging the Battery

Motorola batteries are designed specifically to be used with a Motorola charger and vice-versa. Charging in non-Motorola equipment may lead to battery damage and void the battery warranty. Motorola-authorized battery chargers may not charge batteries other than the ones listed on page 45.

The battery should be at about 77°F (25°C) (room temperature), whenever possible. Charging a cold battery (below 50° F [10°C]) may result in leakage of electrolyte and ultimately in failure of the battery. Charging a hot battery (above 95°F [35°C]) results in reduced discharge capacity, affecting the performance of the radio. Motorola rapid-rate battery chargers contain a temperature-sensing circuit to ensure that batteries are charged within the temperature limits stated above.

Battery Charge Status

Your radio can indicate your battery's charge status by the following:

LED and Sounds

- you see the LED flash red when the PTT Button is pressed indicating low battery
- you hear a low-battery “chirp” (short, high-pitched tone)

Battery Recycling and Disposal

Nickel-cadmium (NiCd) rechargeable batteries can be recycled. However, recycling facilities may not be available in all areas. Under various U.S. state laws and the laws of several other countries, NiCd batteries must be recycled and cannot be disposed of in landfills or incinerators. Contact your local waste management agency for specific requirements and information in your area.

Motorola fully endorses and encourages the recycling of NiCd batteries. In the U.S. and Canada, Motorola participates in the nationwide Rechargeable Battery Recycling Corporation (RBRC) program for NiCd battery collection and recycling. Many retailers and dealers participate in this program.

For the location of the drop-off facility closest to you, access RBRC's Internet web site at www.rbrc.com or call 1-800-8-BATTERY. This internet site and telephone number also provide other useful information concerning recycling options for consumers, businesses, and governmental agencies.

Antenna

Radio Operating Frequencies

Before installing the antenna, make sure it matches your radio's operating frequency. Antennas are frequency sensitive and are color coded according to their frequency range. The color code indicator is located in the center of the antenna's base.

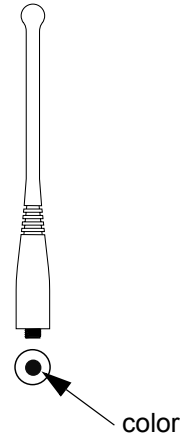

The following antenna types are compatible with your radio:

Antenna Type	Approx. Length		Insulator Color Code	Frequency Range (MHz)	Antenna Kit No.
	in.	mm			
VHF whip	8	203	RED	136–174	NAD6563
VHF helical	7.6	193	YELLOW	136–150.8	NAD6566
VHF helical	7	178	BLACK	150.8–162	NAD6567
VHF helical	6.5	165	BLUE	162–174	NAD6568
UHF helical	3.4	88	RED	403–435	NAE6546
UHF helical	3.2	80	GREEN	435–470	NAE6547
UHF helical	3.2	79	BLACK	470–520	NAE6548
UHF whip, wideband	5.2	130	GRAY	403–520	NAE6549

Helpful Tips

Antenna Type	Approx. Length		Insulator Color Code	Frequency Range (MHz)	Antenna Kit No.
	in.	mm			
800 MHz whip, halfwave	7	178	RED	806–870	NAF5037
800 MHz dipole	8	200	RED	806–870	NAF5039
800 MHz stubby, quarterwave	3.4	86	WHITE	806–870	NAF5042
700/800 MHz whip	7	178	GREEN	764–870	NAF5080

Accessories

Motorola provides the following approved accessories to improve the productivity of your MT 1500 portable two-way radio.

For a list of Motorola-approved antennas, batteries, and other accessories, visit the following web site which lists approved accessories: <http://www.motorola.com/governmentandenterprise>

Antennas

NAD6563	VHF whip (136–174 MHz)
NAD6566	VHF (136–150.8 MHz)
NAD6567	VHF (150.8–162 MHz)
NAD6568	VHF (162–174 MHz)
NAE6546	UHF (403–435 MHz)
NAE6547	UHF (435–470 MHz)
NAE6548	UHF (470–520 MHz)
NAE6549	UHF whip (403–520 MHz)
NAF5037	800 MHz whip, halfwave (806–870 MHz)
NAF4000B	800 MHz dipole (806–870 MHz)
NAF5042	800 MHz stubby, quarterwave (806–870 MHz)
850524U11	700/800 MHz whip (762–870 MHz)

Batteries

NTN9815	NiCd high-capacity
NTN9816	NiCd high-capacity, Factory Mutual Intrinsically Safe
*NTN9857	NiMH ultra-high-capacity, Factory Mutual Intrinsically Safe, IMPRES™
*NTN9858	NiMH ultra-high-capacity, IMPRES™
*NNTN6826	NiMH ultra-high-capacity, Immersible, IMPRES

** Batteries include an over-discharge protection circuit (similar to those in Li-Ion batteries) to extend life of batteries by preventing excessive battery discharge during customer use. Motorola strongly recommends charging these batteries with Motorola-approved IMPRES desktop charges programmed with version 3.4 of the IMPRES™ desktop charger software.*

Carry Accessories

Belt Clips

HLN6853	Belt clip, 2 1/4 inch
---------	-----------------------

Body-Worn

NNTN4115	Carrying case, leather with 3-in. swivel belt loop and T-strap
NNTN4116	Carrying case, leather with 2.5-in. swivel belt loop and T-strap
NNTN4117	Carrying case, leather with 3-in. belt loop and T-strap
NLN6349	Shoulder strap for carrying radio
NTN5243	Shoulder strap for carrying radio
TDN9675	Wrist strap for carrying radio

Chargers

NLN7967	Wall-mount kit for multi-unit charger
NLN7968	Rack-mount kit for multi-unit charger
NTN1168	Single-unit dual rate, rapid charger 120V
NTN1169	Single-unit dual rate, rapid charger 220V (2-prong Euro plug)
NTN1170	Single-unit dual rate, rapid charger 240V (3-prong UK plug)
NTN1177	Multi-unit, dual rate, rapid charger 110V
NTN1178	Multi-unit, dual rate, rapid charger 240V (3-prong UK plug)
NTN1179	Multi-unit, rapid charger 240V (UK 13 MAP Plug)
NTN1667	Tri-chemistry, 110V
NTN1668	Tri-Chemistry, 220V Single Unit Charger (2 Prong Euro Plug)
NTN1669	Tri-chemistry, 230V
NTN1873	IMPRES™ rapid charger 110V single-unit
NTN1874	IMPRES™ rapid charger 220V single-unit
NTN1875	IMPRES™ rapid charger 240V single-unit
NTN4796	Multi-unit, tri-chemistry, rapid rate, 110V
NTN7209	Single-unit dual rate, rapid charger w/o cord
RLN4884	Single-unit Travel Charger

Enhanced and Multi-Unit Line Cords

NTN7373	110V interchangeable line
NTN7374	220V interchangeable line (2-prong Euro plug)
NTN7375	240V interchangeable line (3-prong UK plug)

Microphones, Remote Speaker

NMN6191	Remote speaker mic, noise-canceling (includes 6.0-ft coiled cord assembly, 3.5-mm earjack, swivel clip, quick disconnect)
NMN6193	Remote speaker mic
NNTN4285	Remote speaker mic adapter
RMN5074	18 inch Public Safety Microphone, straight cable
RMN5073	24 inch Public Safety Microphone, straight cable
RMN5072	30 inch Public Safety Microphone, straight cable
ZMN6031	Speaker mic, 3-piece
ZMN6032	Speaker mic, 2-piece
ZMN6038	Speaker mic, 2-piece, extra loud
ZMN6039	Speaker mic, 3-piece, extra loud

Surveillance Accessories

CommPort[®] Integrated Microphone/Receivers

NTN1624	CommPort with palm PTT
NTN1625	CommPort ear mic with PTT for noise levels up to 100 dB (requires BDN6676 adapter)
NTN1663	CommPort ear mic with ring PTT for noise levels up to 100 dB (requires BDN6676 adapter)
NTN1736	CommPort ear mic with snap-on side PTT for noise levels up to 100 dB (requires BDN6676 adapter)

Earpieces

BDN6641	Ear mic, high noise level up to 105 dB, grey (must order BDN6671 interface module)
---------	--

BDN6664	Earpiece with standard earphone, beige
BDN6665	Earpiece with extra-loud earphone (exceeds OSHA limits), beige
BDN6666	Earpiece with volume control, beige
BDN6667	Earpiece, mic and PTT combined, beige
BDN6668	Earpiece, mic and PTT separate, beige
BDN6669	Earpiece, mic and PTT combined, with extra-loud earphone (exceeds OSHA limits), beige
BDN6670	Earpiece, mic and PTT separate with extra-loud earphone (exceeds OSHA limits), beige
BDN6677	Ear mic, standard, noise up to 95 dB (must order BDN6671 interface module), black
BDN6678	Ear mic, standard, noise up to 95 dB (must order BDN6671 interface module), beige
BDN6719	Earpad, with 3.5mm threaded plug
BDN6726	Earpiece with standard earphone, black
BDN6727	Earpiece with extra-loud earphone (exceeds OSHA limits), black
BDN6728	Earpiece with volume control, black
BDN6729	Earpiece, mic and PTT combined, black
BDN6730	Earpiece, mic and PTT separate, black
BDN6731	Earpiece, mic and PTT combined, with extra-loud earphone (exceeds OSHA limits), black
BDN6732	Earpiece, mic and PTT separate, with extra-loud earphone (exceeds OSHA limits), black
BDN6780	Earbud, single with mic and PTT combined, beige
BDN6781	Earbud, single, receive only, black

Headsets and Headset Accessories

BDN6635	Heavy-duty VOX headset with noise-canceling boom mic (requires BDN6673 adapter)
BDN6636	Heavy-duty VOX headset with throat mic (requires BDN6673)
BDN6645	Noise-canceling boom mic headset with PTT on earcup
BDN6673	Headset adapter cable (for use with BDN6635 and BDN6645)
BDN6676	Adapter
NMN1020	Safety helmet headset (requires BDN6676 adapter)
NMN6245	Light-weight headset
NMN6246	Ultralite headset with boom mic
NMN6258	Over-the-head headset with in-line PTT
NMN6259	Medium-weight, dual headset with NC mic
RMN4049	Temple transducer

Radio Interface Modules for Ear Microphones

BDN6671	Push-to-talk (PTT) and voice-activated (VOX) interface module (for use with BDN6641, BDN6677 and BDN6678)
BDN6708	PTT interface module (for use with BDN6641, BDN6677 and BDN6678)

Switches

0180300E83	Remote PTT body switch
NTN7660	Tilt / man down switch

Appendix: Maritime Radio Use in the VHF Frequency Range

Special Channel Assignments

Emergency Channel

If you are in imminent and grave danger at sea and require emergency assistance, use **VHF Channel 16** to send a distress call to nearby vessels and the United States Coast Guard. Transmit the following information, in this order:

- 1 "MAYDAY, MAYDAY, MAYDAY."
- 2 "THIS IS _____, CALL SIGN _____."
State the name of the vessel in distress 3 times, followed by the call sign or other identification of the vessel, stated 3 times.
- 3 Repeat "MAYDAY" and the name of the vessel.
- 4 "WE ARE LOCATED AT _____."
State the position of the vessel in distress, using any information that will help responders to locate you, e.g.:
 - latitude and longitude
 - bearing (state whether you are using true or magnetic north)
 - distance to a well-known landmark
 - vessel course, speed or destination
- 5 State the nature of the distress.
- 6 Specify what kind of assistance you need.
- 7 State the number of persons on board and the number needing medical attention, if any.
- 8 Mention any other information that would be helpful to responders, such as type of vessel, vessel length and/or tonnage, hull color, etc.
- 9 "OVER."
- 10 Wait for a response.
- 11 If you do not receive an immediate response, remain by the radio and repeat the transmission at intervals until you receive a response. Be prepared to follow any instructions given to you.

Non-Commercial Call Channel

For non-commercial transmissions, such as fishing reports, rendezvous arrangements, repair scheduling, or berthing information, use **VHF Channel 9**.

Operating Frequency Requirements

A radio designated for shipboard use must comply with Federal Communications Commission Rule Part 80 as follows:

- on ships subject to Part II of Title III of the Communications Act, the radio must be capable of operating on the 156.800 MHz frequency
- on ships subject to the Safety Convention, the radio must be capable of operating:
 - in the simplex mode on the ship station transmitting frequencies specified in the 156.025–157.425 MHz frequency band, and
 - in the semiduplex mode on the two frequency channels specified in the table below.

Note: Simplex channels 3, 21, 23, 61, 64, 81, 82, and 83 **cannot be lawfully used** by the general public in US waters.

Additional information about operating requirements in the Maritime Services can be obtained from the full text of FCC Rule Part 80 and from the US Coast Guard.

Table A-1: VHF Marine Channel List

Channel Number	Frequency (MHz)	
	Transmit	Receive
1	156.050	160.650
2	156.100	160.700
*	156.150	160.750
4	156.200	160.800
5	156.250	160.850
6	156.300	–
7	156.350	160.950

Table A-1: VHF Marine Channel List (Continued)

Channel Number	Frequency (MHz)	
	Transmit	Receive
8	156.400	–
9	156.450	156.450
10	156.500	156.500
11	156.550	156.550
12	156.600	156.600
13**	156.650	156.650
14	156.700	156.700
15**	156.750	156.750
16	156.800	156.800
17**	156.850	156.850
18	156.900	161.500
19	156.950	161.550
20	157.000	161.600
*	157.050	161.650
22	157.100	161.700
*	157.150	161.750
24	157.200	161.800
25	157.250	161.850
26	157.300	161.900
27	157.350	161.950
28	157.400	162.000
60	156.025	160.625
*	156.075	160.675
62	156.125	160.725
63	156.175	160.775
*	156.225	160.825
65	156.275	160.875
66	156.325	160.925

Table A-1: VHF Marine Channel List (Continued)

Channel Number	Frequency (MHz)	
	Transmit	Receive
67**	156.375	156.375
68	156.425	156.425
69	156.475	156.475
71	156.575	156.575
72	156.625	–
73	156.675	156.675
74	156.725	156.725
75	***	***
76	***	***
77**	156.875	–
78	156.925	161.525
79	156.975	161.575
80	157.025	161.625
*	157.075	161.675
*	157.125	161.725
*	157.175	161.775
84	157.225	161.825
85	157.275	161.875
86	157.325	161.925
87	157.375	161.975
88	157.425	162.025

* Simplex channels 3, 21, 23, 61, 64, 81, 82, and 83 **cannot be lawfully used** by the general public in US waters.

** Low power (1 W) only

*** Guard band

Note: A – in the Receive column indicates that the channel is transmit only.

Glossary

This is a list of specialized terms used in this manual.

ACK	Acknowledgment of communication.
Active Channel	A channel that has traffic on it.
Analog Signal	An RF signal that has a continuous nature rather than a pulsed or discrete nature.
Call Alert	A page received by your radio, along with an audible tone.
Carrier Squelch	Feature that responds to the presence of an RF carrier by opening or unmuting (turning on) a receiver's audio circuit. A squelch circuit silences the radio when no signal is being received so that the user does not have to listen to noise.
Central Controller	A software controlled, computer-driven device that receives and generates data for the trunked radios assigned to it. It monitors and directs the operations of the trunked repeaters.
Channel	A group of characteristics such as transmit/receive frequency pairs, radio parameters, and encryption encoding.
Control Channel	In a trunking system, one of the channels that is used to provide a continuous, two-way/data communications path between the central controller and all radios on the system.
Conventional	Typically refers to radio-to-radio communications, sometimes through a repeater. (See Trunking.)
Digital Signal	An RF signal that has a pulsed, or discrete nature, rather than a continuous nature.
Dispatcher	An individual who has radio system management duties.

Dynamic Regrouping	A feature that allows the dispatcher to temporarily reassign selected radios to a single special channel so they can communicate with each other.
Failsoft	A feature that allows communications to take place even though the central controller has failed. Each trunked repeater in the system will transmit a data word informing every radio that the system has gone into failsoft.
FCC	Federal Communications Commission.
Hang Up	Disconnect.
LED	Light-emitting diode.
Monitor	Check channel activity by pressing the Monitor button. If the channel is clear, you will hear static. If the channel is in use, you will hear conversation. It also serves as a way to check the volume level of the radio, as the radio will “open the squelch” when pressing the monitor button.
NiCd	Nickel Cadmium.
NiMH	Nickel Metal Hydride.
Non-tactical/Revert	The user will talk on a preprogrammed emergency channel. The emergency alarm is sent on this same channel.
Page	A one-way alert, with audio messages.
Personality	A set of unique features specific to a radio.
Preprogrammed	A feature that has been assigned in advance by a qualified technician.
Private (Conversation) Call	Allows you to respond to a private conversation call from another radio user in the group.

Private Line (PL)	A sub-audible tone that is transmitted such that only receivers decoding this tone will hear the message.
Programmable	A radio control that can have a radio feature assigned to it.
PTT	Push-To-Talk — the PTT button engages the transmitter and puts the radio in transmit (send) operation when pressed.
Radio Frequency (RF)	The part of the general frequency spectrum between the audio and infrared light regions (about 10 kHz to 10,000,000 MHz).
Repeater	A conventional radio feature, where you talk through a receive/transmit facility (repeater), that re-transmits received signals in order to improve communications range and coverage.
Squelch	Special electronic circuitry added to the receiver of a radio which reduces, or squelches, unwanted signals before they are heard in the speaker.
Standby	An operating condition whereby the radio's speaker is muted but still continues to receive data.
Tactical/Non-revert	The user will talk on the channel that was selected before the radio entered the emergency state.
Talkaround	Bypass a repeater and talk directly to another unit for easy local unit-to-unit communications.
Talkgroup	An organization of radio users who communicate with each other.

Glossary

Trunking	The automatic sharing of communications paths between a large number of users. (See Conventional.)
Zone	A grouping of channels.

Commercial Warranty

Limited Warranty

MOTOROLA COMMUNICATION PRODUCTS

I. WHAT THIS WARRANTY COVERS AND FOR HOW LONG:

MOTOROLA INC. (“MOTOROLA”) warrants the MOTOROLA manufactured Communication Products listed below (“Product”) against defects in material and workmanship under normal use and service for a period of time from the date of purchase as scheduled below:

MT 1500 Portable Units	One (1) Year
Product Accessories	One (1) Year

Motorola, at its option, will at no charge either repair the Product (with new or reconditioned parts), replace it (with a new or reconditioned Product), or refund the purchase price of the Product during the warranty period provided it is returned in accordance with the terms of this warranty. Replaced parts or boards are warranted for the balance of the original applicable warranty period. All replaced parts of Product shall become the property of MOTOROLA.

This express limited warranty is extended by MOTOROLA to the original end user purchaser only and is not assignable or transferable to any other party. This is the complete warranty for the Product manufactured by MOTOROLA. MOTOROLA assumes no obligations or liability for additions or modifications to this warranty unless made in writing and signed by an officer of MOTOROLA. Unless made in a separate agreement between MOTOROLA and the original end user purchaser, MOTOROLA does not warrant the installation, maintenance or service of the Product.

MOTOROLA cannot be responsible in any way for any ancillary equipment not furnished by MOTOROLA which is attached to or used in connection with the Product, or for operation of the Product with any ancillary equipment, and all such equipment is expressly excluded from this warranty. Because each system which may use

the Product is unique, MOTOROLA disclaims liability for range, coverage, or operation of the system as a whole under this warranty.

II. GENERAL PROVISIONS:

This warranty sets forth the full extent of MOTOROLA'S responsibilities regarding the Product. Repair, replacement or refund of the purchase price, at MOTOROLA's option, is the exclusive remedy. THIS WARRANTY IS GIVEN IN LIEU OF ALL OTHER EXPRESS WARRANTIES. IMPLIED WARRANTIES, INCLUDING WITHOUT LIMITATION, IMPLIED WARRANTIES OF MERCHANTABILITY AND FITNESS FOR A PARTICULAR PURPOSE, ARE LIMITED TO THE DURATION OF THIS LIMITED WARRANTY. IN NO EVENT SHALL MOTOROLA BE LIABLE FOR DAMAGES IN EXCESS OF THE PURCHASE PRICE OF THE PRODUCT, FOR ANY LOSS OF USE, LOSS OF TIME, INCONVENIENCE, COMMERCIAL LOSS, LOST PROFITS OR SAVINGS OR OTHER INCIDENTAL, SPECIAL OR CONSEQUENTIAL DAMAGES ARISING OUT OF THE USE OR INABILITY TO USE SUCH PRODUCT, TO THE FULL EXTENT SUCH MAY BE DISCLAIMED BY LAW.

III. STATE LAW RIGHTS:

SOME STATES DO NOT ALLOW THE EXCLUSION OR LIMITATION OF INCIDENTAL OR CONSEQUENTIAL DAMAGES OR LIMITATION ON HOW LONG AN IMPLIED WARRANTY LASTS, SO THE ABOVE LIMITATION OR EXCLUSIONS MAY NOT APPLY.

This warranty gives specific legal rights, and there may be other rights which may vary from state to state.

IV. HOW TO GET WARRANTY SERVICE:

You must provide proof of purchase (bearing the date of purchase and Product item serial number) in order to receive warranty service and, also, deliver or send the Product item, transportation and insurance prepaid, to an authorized warranty service location. Warranty service will be provided by Motorola through one of its authorized warranty service locations. If you first contact the company

which sold you the Product, it can facilitate your obtaining warranty service. You can also call Motorola at 1-888-567-7347 US/Canada.

V. WHAT THIS WARRANTY DOES NOT COVER:

- A) Defects or damage resulting from use of the Product in other than its normal and customary manner.
- B) Defects or damage from misuse, accident, water, or neglect.
- C) Defects or damage from improper testing, operation, maintenance, installation, alteration, modification, or adjustment.
- D) Breakage or damage to antennas unless caused directly by defects in material workmanship.
- E) A Product subjected to unauthorized Product modifications, disassemblies or repairs (including, without limitation, the addition to the Product of non-Motorola supplied equipment) which adversely affect performance of the Product or interfere with Motorola's normal warranty inspection and testing of the Product to verify any warranty claim.
- F) Product which has had the serial number removed or made illegible.
- G) Rechargeable batteries if:
 - any of the seals on the battery enclosure of cells are broken or show evidence of tampering.
 - the damage or defect is caused by charging or using the battery in equipment or service other than the Product for which it is specified.
- H) Freight costs to the repair depot.
- I) A Product which, due to illegal or unauthorized alteration of the software/firmware in the Product, does not function in accordance with MOTOROLA's published specifications or the FCC type acceptance labeling in effect for the Product at

the time the Product was initially distributed from MOTOROLA.

- J) Scratches or other cosmetic damage to Product surfaces that does not affect the operation of the Product.
- K) Normal and customary wear and tear.

VI. PATENT AND SOFTWARE PROVISIONS:

MOTOROLA will defend, at its own expense, any suit brought against the end user purchaser to the extent that it is based on a claim that the Product or parts infringe a United States patent, and MOTOROLA will pay those costs and damages finally awarded against the end user purchaser in any such suit which are attributable to any such claim, but such defense and payments are conditioned on the following:

- A) that MOTOROLA will be notified promptly in writing by such purchaser of any notice of such claim;
- B) that MOTOROLA will have sole control of the defense of such suit and all negotiations for its settlement or compromise; and
- C) should the Product or parts become, or in MOTOROLA's opinion be likely to become, the subject of a claim of infringement of a United States patent, that such purchaser will permit MOTOROLA, at its option and expense, either to procure for such purchaser the right to continue using the Product or parts or to replace or modify the same so that it becomes non-infringing or to grant such purchaser a credit for the Product or parts as depreciated and accept its return. The depreciation will be an equal amount per year over the lifetime of the Product or parts as established by MOTOROLA.

MOTOROLA will have no liability with respect to any claim of patent infringement which is based upon the combination of the Product or parts furnished hereunder with software, apparatus or devices not furnished by MOTOROLA, nor will MOTOROLA have any liability for

the use of ancillary equipment or software not furnished by MOTOROLA which is attached to or used in connection with the Product. The foregoing states the entire liability of MOTOROLA with respect to infringement of patents by the Product or any parts thereof.

Laws in the United States and other countries preserve for MOTOROLA certain exclusive rights for copyrighted MOTOROLA software such as the exclusive rights to reproduce in copies and distribute copies of such Motorola software. MOTOROLA software may be used in only the Product in which the software was originally embodied and such software in such Product may not be replaced, copied, distributed, modified in any way, or used to produce any derivative thereof. No other use including, without limitation, alteration, modification, reproduction, distribution, or reverse engineering of such MOTOROLA software or exercise of rights in such MOTOROLA software is permitted. No license is granted by implication, estoppel or otherwise under MOTOROLA patent rights or copyrights.

VII. GOVERNING LAW:

This Warranty is governed by the laws of the State of Illinois, USA.

Index

A

accessories	
antennas	43
batteries	44
belt clips	44
carry cases	44
chargers	45
earpieces	46
headsets	48
microphones, remote	
speaker	46
radio interface modules	48
surveillance	46
switches	48
alert tones	5
analog squelch	23
answer a private call	32
antenna	
attach the antenna	11
radio operating frequencies	41
remove the antenna	11
antennas	43

B

batteries	44
battery	
attach the battery	10
battery charge status	39
charging the battery	9
recycling and disposal	40
remove the battery	10
belt clip	
attach the belt clip	12
remove the belt clip	12
belt clips	44

C

call alert	
answer a call alert	33
carry accessories	
belt clips	44
body-worn	44

channel	
select a channel	16
chargers	
enhanced and multi-unit line	
cords	45
conventional mode operation	21

E

emergency	
emergency keep-alive	29
send an emergency alarm	26
send an emergency call	27

F

failsoft	35
----------	----

G

glossary	53
----------	----

L

LED indicators	5
----------------	---

M

microphones, remote speaker	46
mode select button	17
monitor button	20

N

notations used in this manual	1
-------------------------------	---

O

out-of-range	35
--------------	----

P

phone call	
answer a phone call	31
physical features of the radio	3
PL defeat	23
programmable features	3

Index

R

- radio care
 - cleaning37
 - handling37
- receive / transmit
 - use the preprogrammed
 - monitor button20
 - use the preprogrammed
 - volume set button 19
 - without using the volume set
 - and monitor buttons 18
- remote speaker microphone
 - adapter 14
 - attach the adapter 14
 - remove the adapter 14
 - repeater or direct operation34
 - repeater/direct switch34

S

- scan
 - delete a nuisance channel30
 - turn scan on and off30
- select a channel 16
- select a zone 16
- service38
- site change36
- site lock36
- surveillance accessories46
 - Commport integrated
 - microphone/receivers 46
 - earpieces46
 - headsets and headset
 - accessories48
 - radio interface modules for ear
 - microphones48
- switches48

T

- time-out timer24
- Trunking System Controls35
- turn the radio off 15
- turn the radio on 15

U

- universal connector cover
 - attach the connector cover 13
 - remove the connector cover ... 13

V

- volume set button 19

W

- warranty 57

Z

- zone
 - select a zone 16



MOTOROLA

Motorola, Inc.
1301 E. Algonquin Rd.
Schaumburg, IL60196-1078, USA.

MOTOROLA, the Stylized M Logo, ASTRO,
and SmartZone are registered in the U.S.
Patent & Trademark Office.

All other product or service names are the
property of their respective owners.

© 2007, 2008 by Motorola, Inc.

All rights reserved. Printed in U.S.A.



6816983H01-D